

Project North

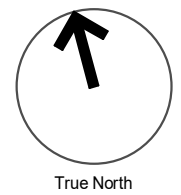

True North

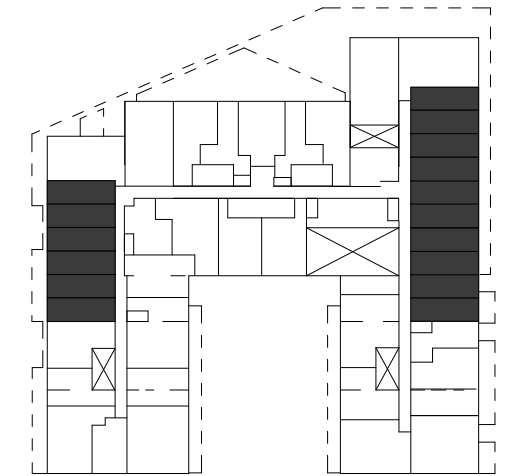
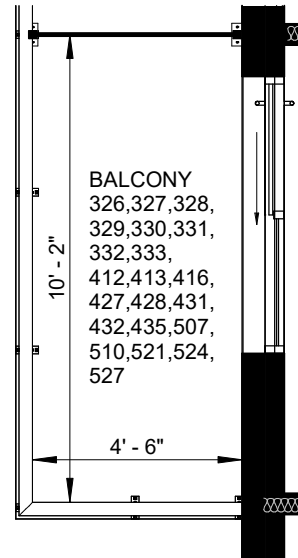

LEVEL 3

- UNITS - 311 - 299 SF
- 312 - 229 SF
- 313 - 299 SF
- 314 - 299 SF
- 315 - 299 SF
- 316 - 299 SF
- 326 - 299 SF
- 327 - 299 SF
- 328 - 299 SF
- 329 - 299 SF
- 330 - 299 SF
- 331 - 299 SF
- 332 - 299 SF
- 333 - 299 SF
- 334 - 299 SF
- 335 - 299 SF
- 411 - 299 SF
- 412 - 299 SF
- 413 - 299 SF
- 414 - 299 SF
- 415 - 299 SF
- 416 - 299 SF
- 426 - 299 SF
- 427 - 299 SF
- 428 - 299 SF
- 429 - 299 SF
- 430 - 299 SF
- 431 - 299 SF
- 432 - 299 SF
- 433 - 299 SF
- 434 - 299 SF
- 435 - 299 SF
- 507 - 299 SF
- 508 - 299 SF
- 509 - 299 SF
- 510 - 299 SF
- 521 - 299 SF
- 522 - 299 SF
- 523 - 299 SF
- 524 - 299 SF
- 526 - 299 SF
- 527 - 299 SF

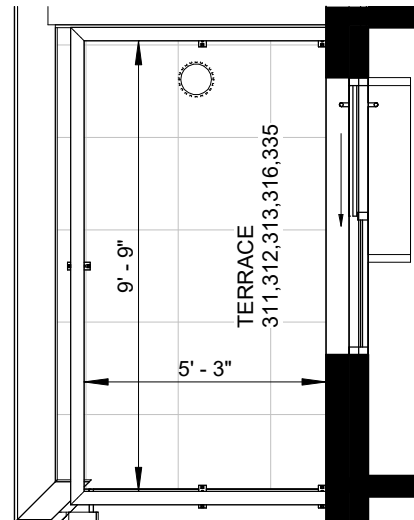

314,315,334,411,414,415,
426,429,430,433,434,508,
509,522,523,526

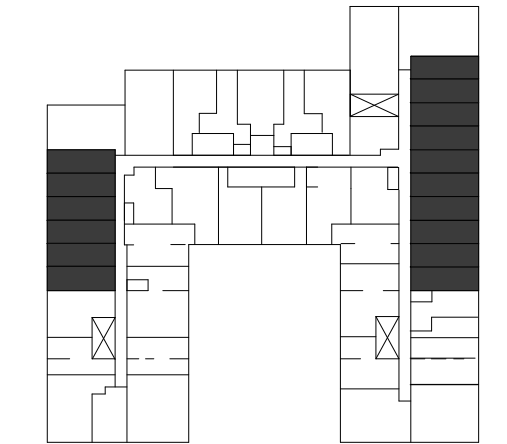
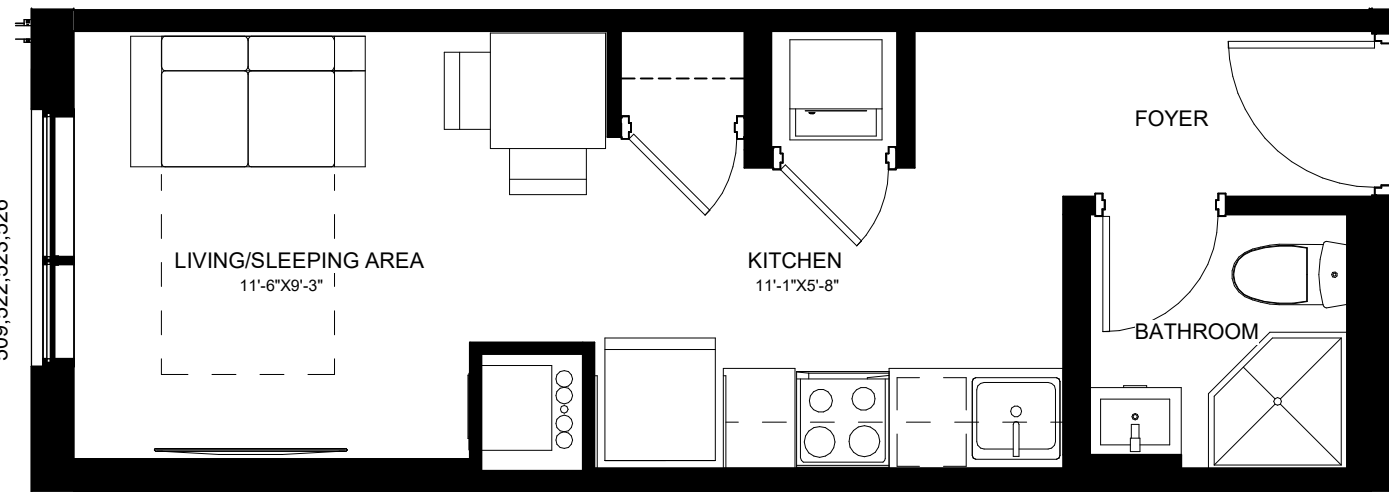

LEVEL 4

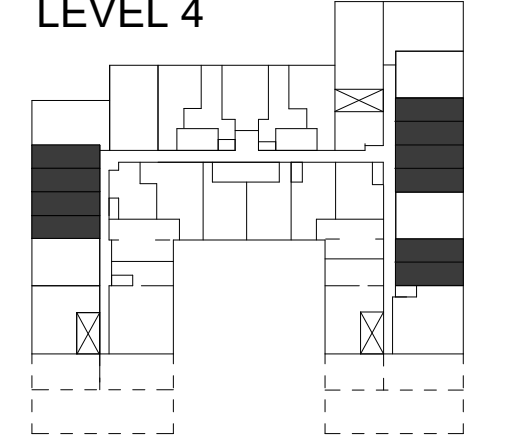

LEVEL 5

SUITE TYPE A299

1107 MAIN ST. W

19052

SRM[↑]
architects+
urban*designers

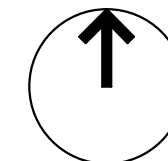

Project North

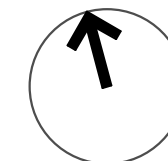

True North

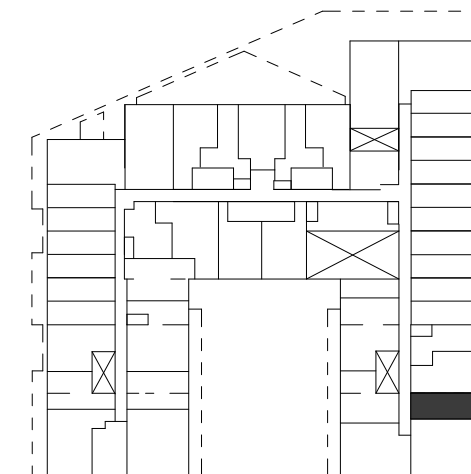

LEVEL 3

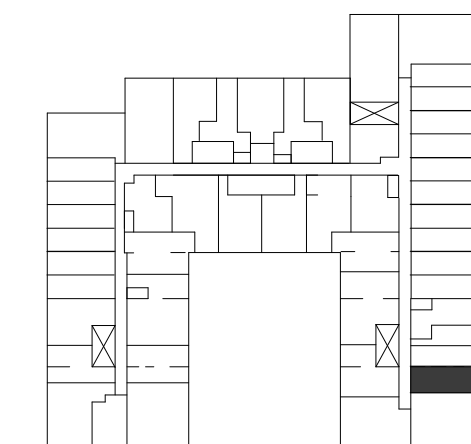

LEVEL 4

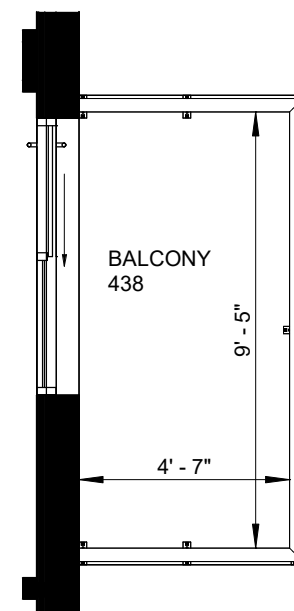
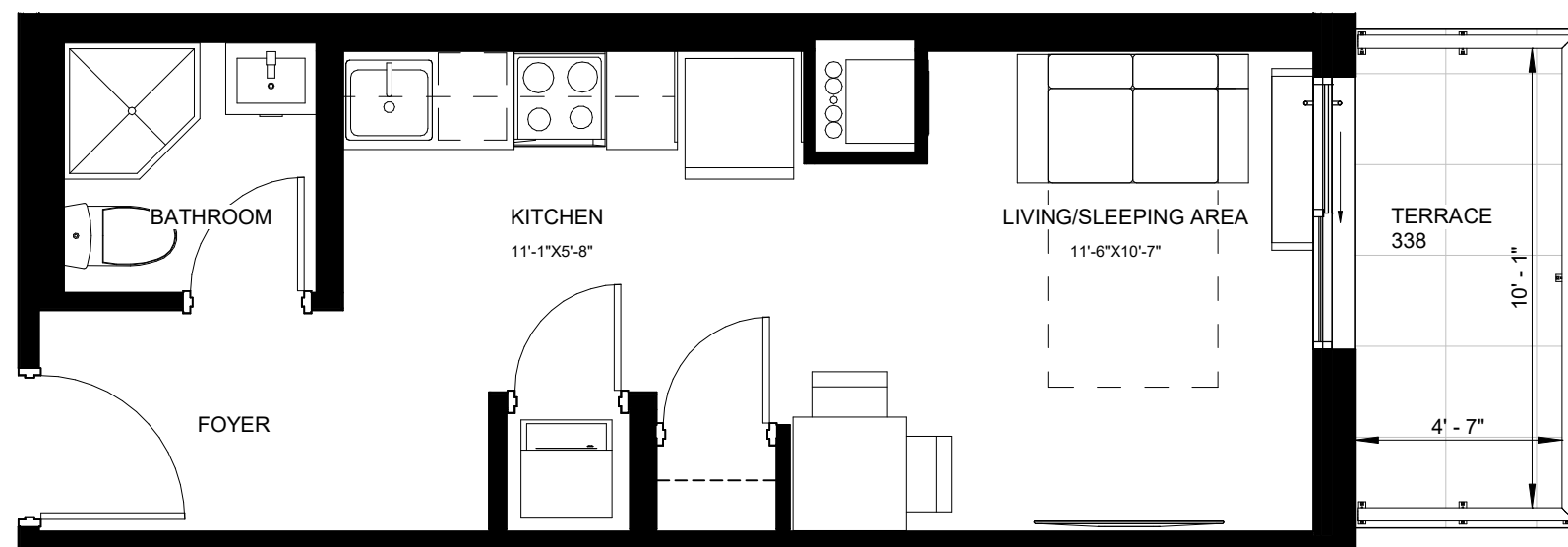

UNITS - 338 - 337 SF
438 - 337 SF

SUITE TYPE A337

1107 MAIN ST. W

19052



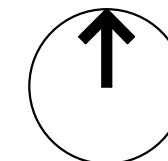

Project North

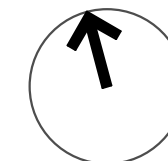

True North

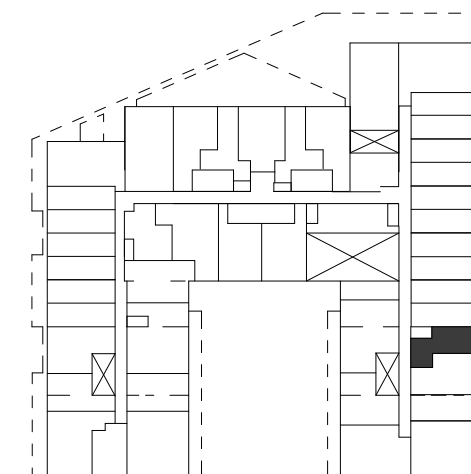
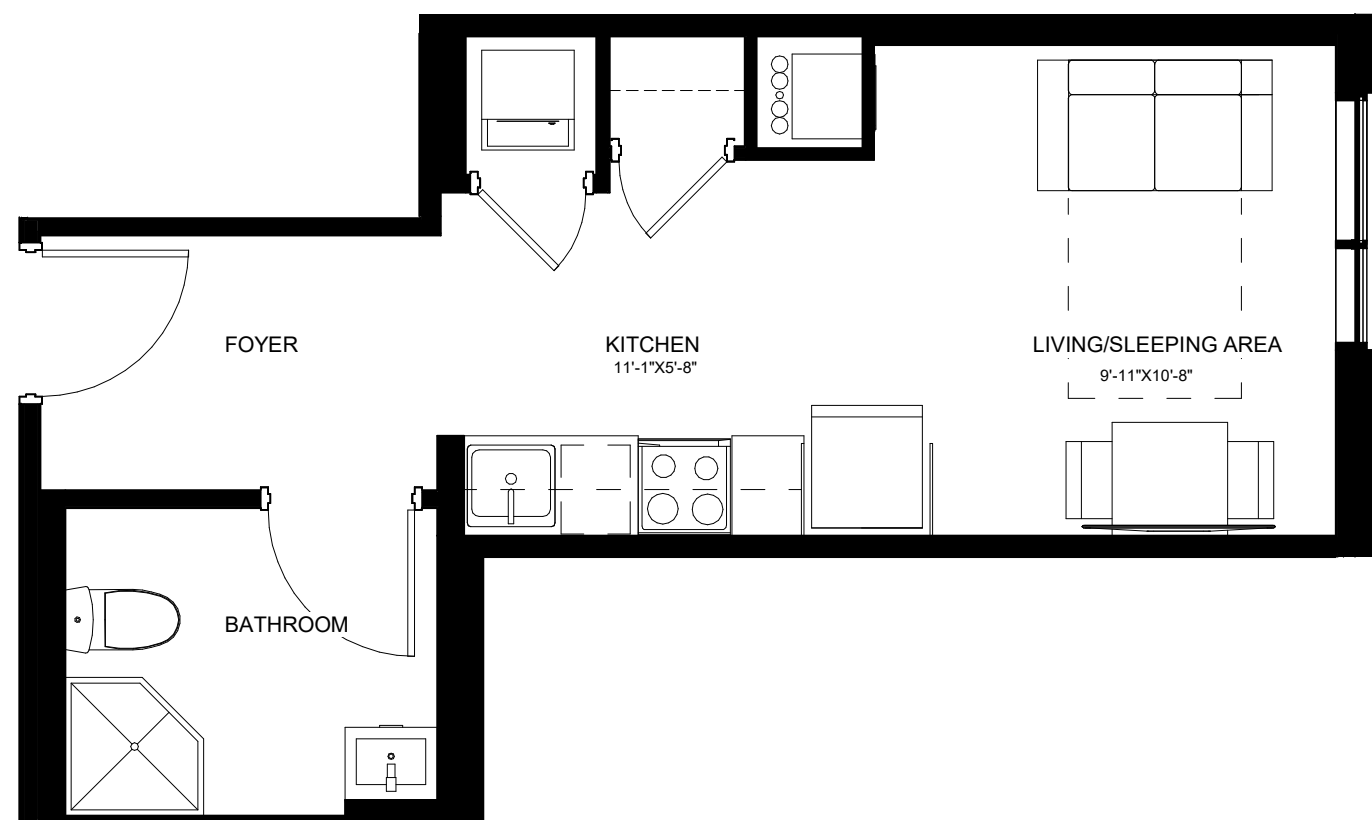

LEVEL 3

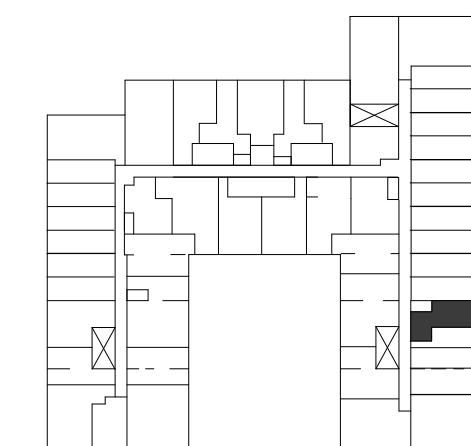

LEVEL 4

UNITS - 336 - 352 SF
436 - 352 SF

SUITE TYPE A352

1107 MAIN ST. W

19052



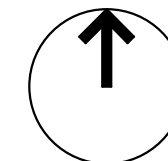

Project North

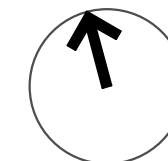

True North

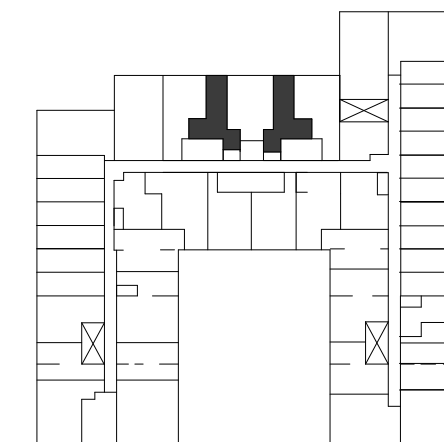
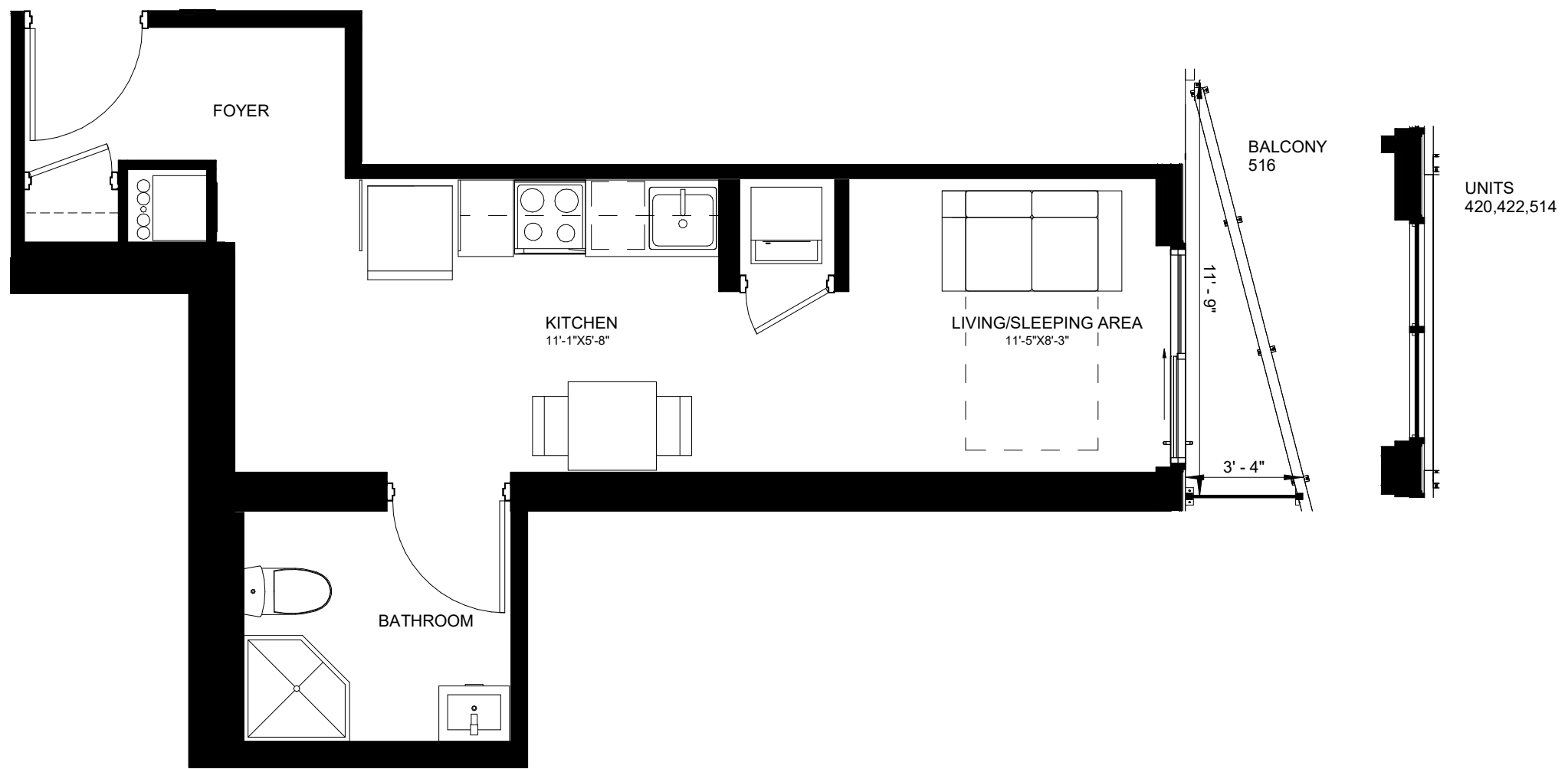

LEVEL 4

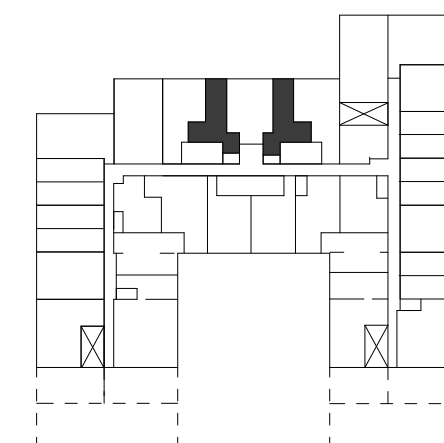

LEVEL 5

UNITS - 420 - 371 SF
 422 - 368 SF
 514 - 371 SF
 516 - 368 SF

SUITE TYPE A371

1107 MAIN ST. W

19052

SRM[↗]
 architects+
 urban+designers

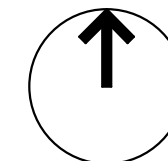

Project North

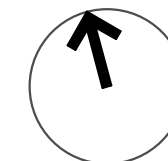

True North

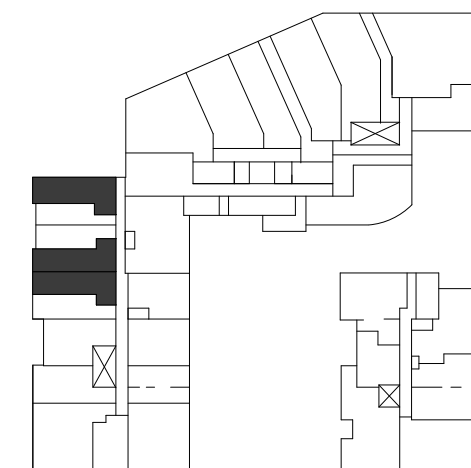

LEVEL 2

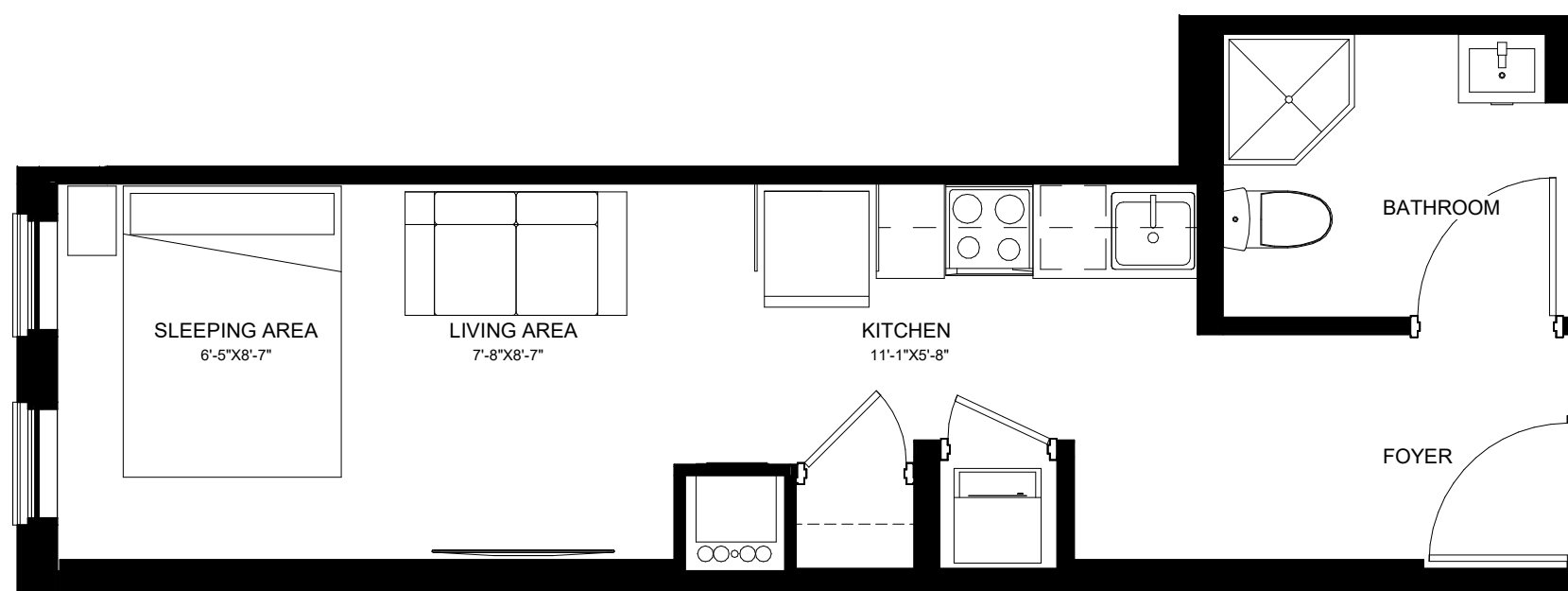

UNITS - 210 - 375 SF
 211 - 375 SF
 214 - 393 SF

SUITE TYPE A375

1107 MAIN ST. W

19052

SRM[↗]
 architects+
 urban+designers

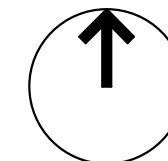

Project North

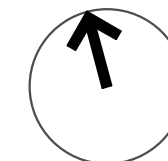

True North

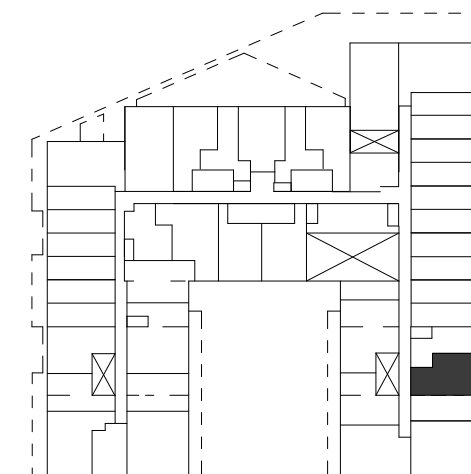
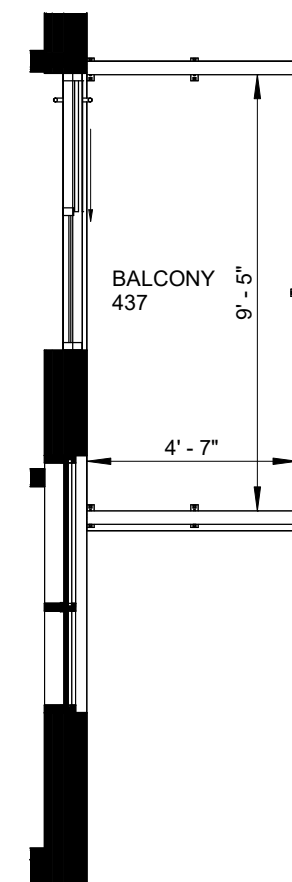
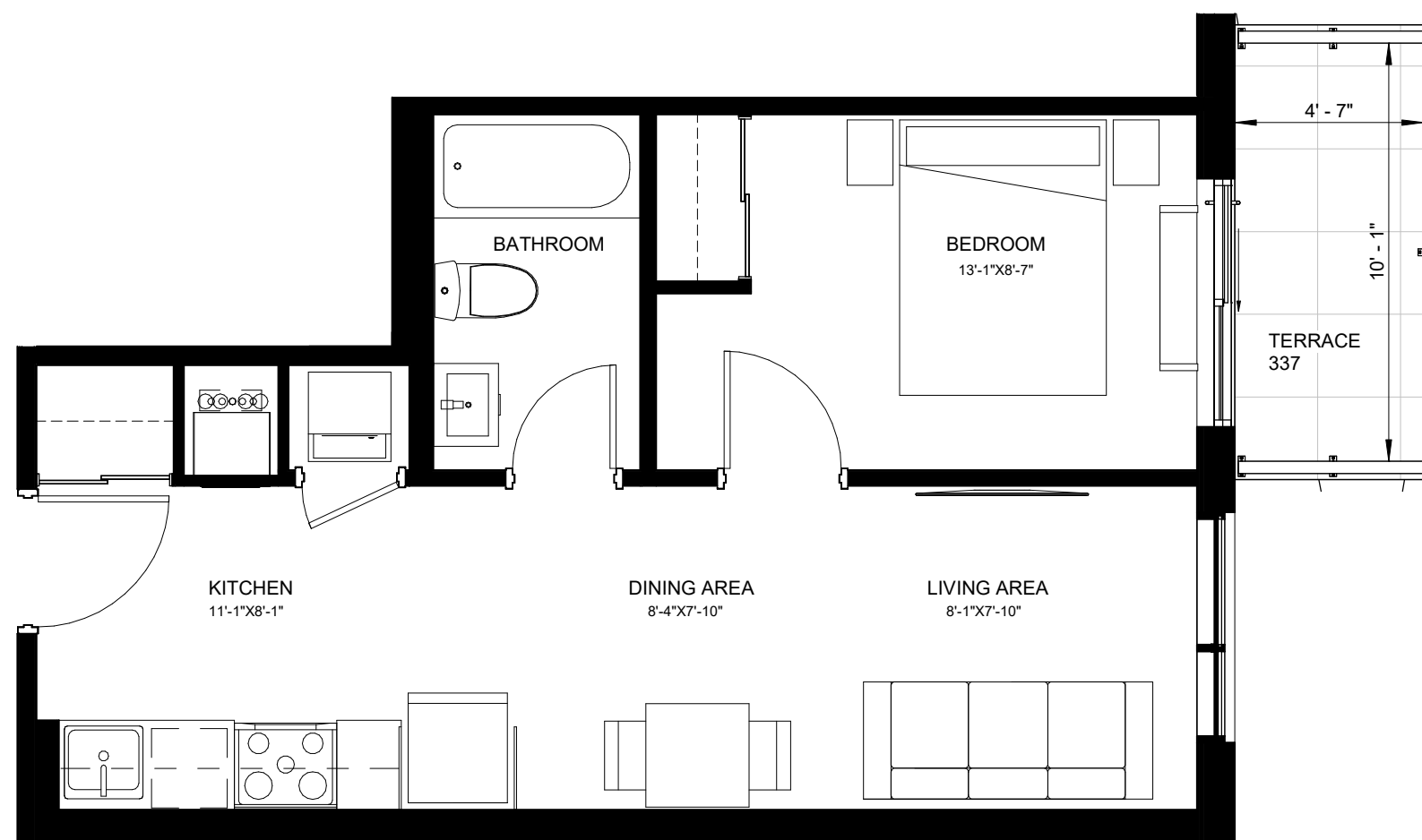

LEVEL 3

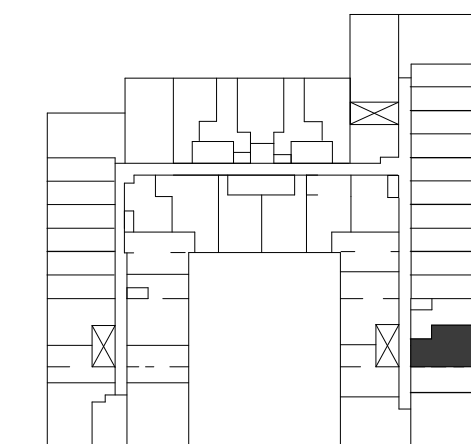

LEVEL 4

UNITS - 337 - 465 SF
437 - 465 SF

SUITE TYPE B465

1107 MAIN ST. W

19052



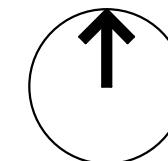

Project North

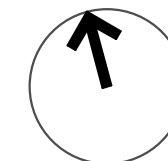

True North

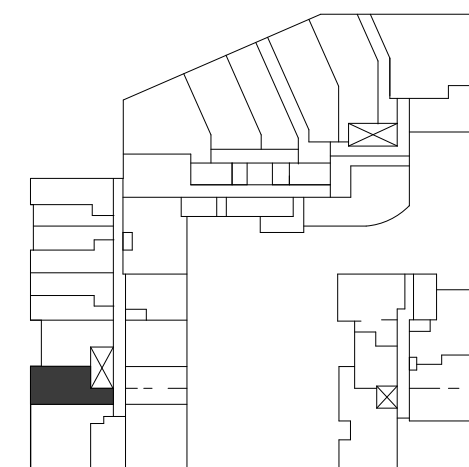
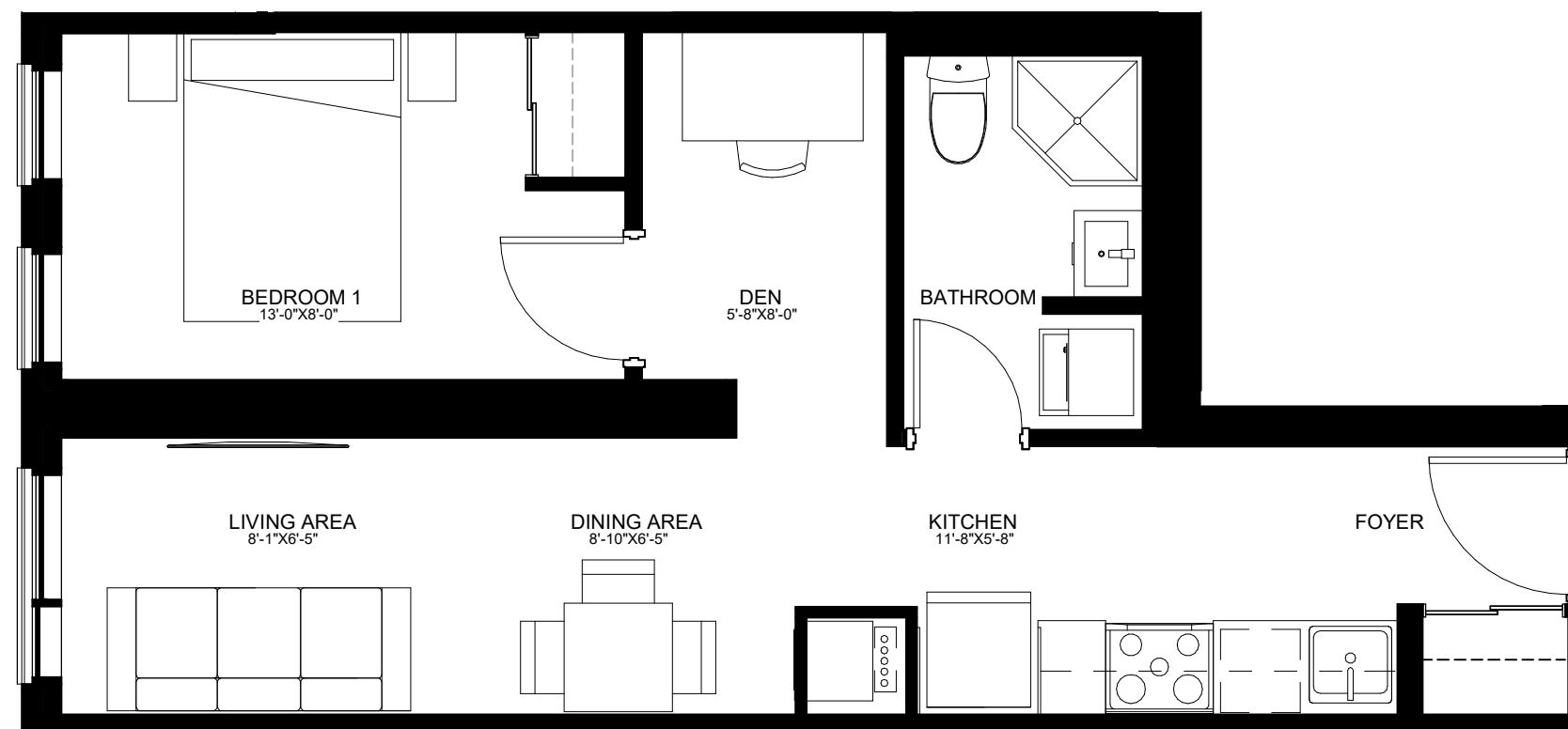

LEVEL 2

UNIT - 207 - 493 SF

SUITE TYPE C493

1107 MAIN ST. W

19052

SRM[↗]
 architects+
 urban+designers

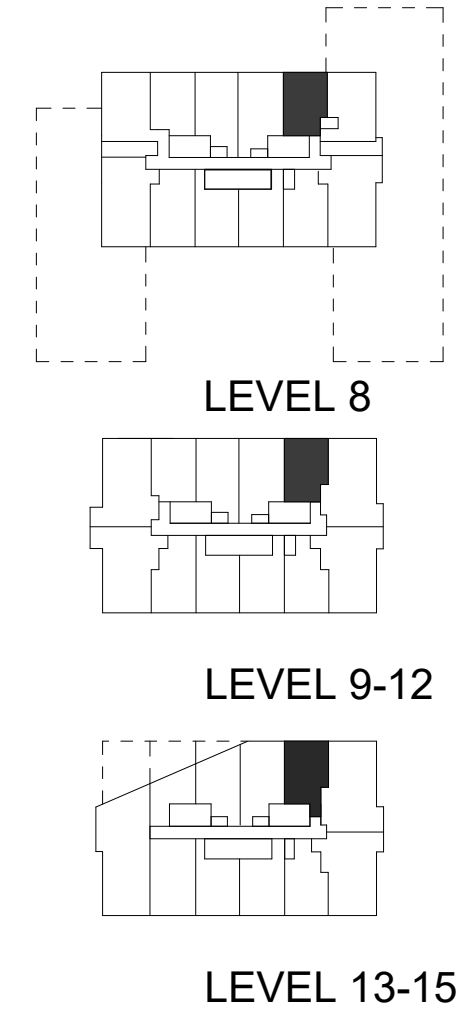
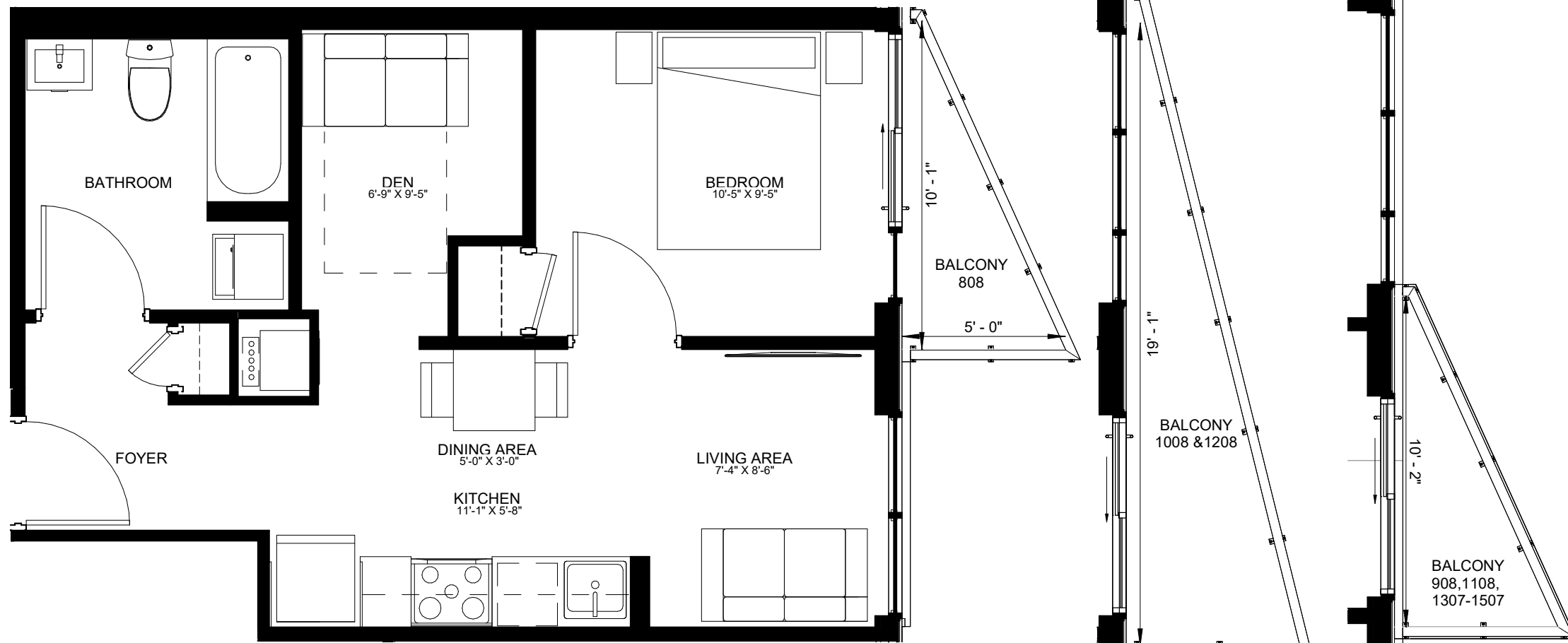
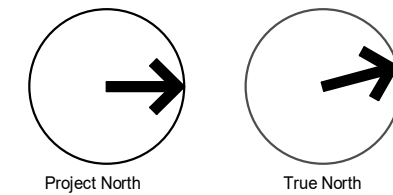

- UNITS - 808 - 501 SF
- 909 - 501 SF
- 1009 - 501 SF
- 1109 - 501 SF
- 1209 - 501 SF
- 1307 - 501 SF
- 1407 - 501 SF
- 1507 - 501 SF

SUITE TYPE C501
 1107 MAIN ST. W

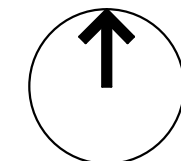

Project North

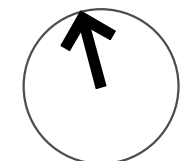

True North

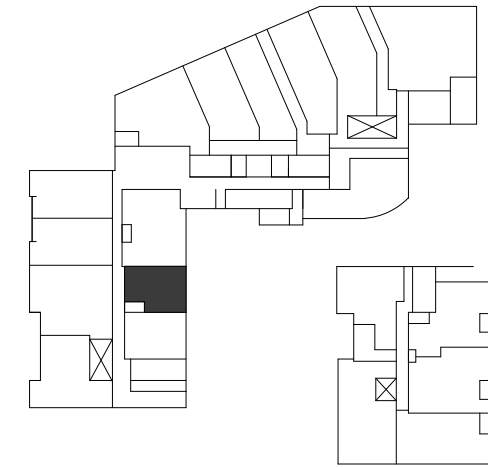
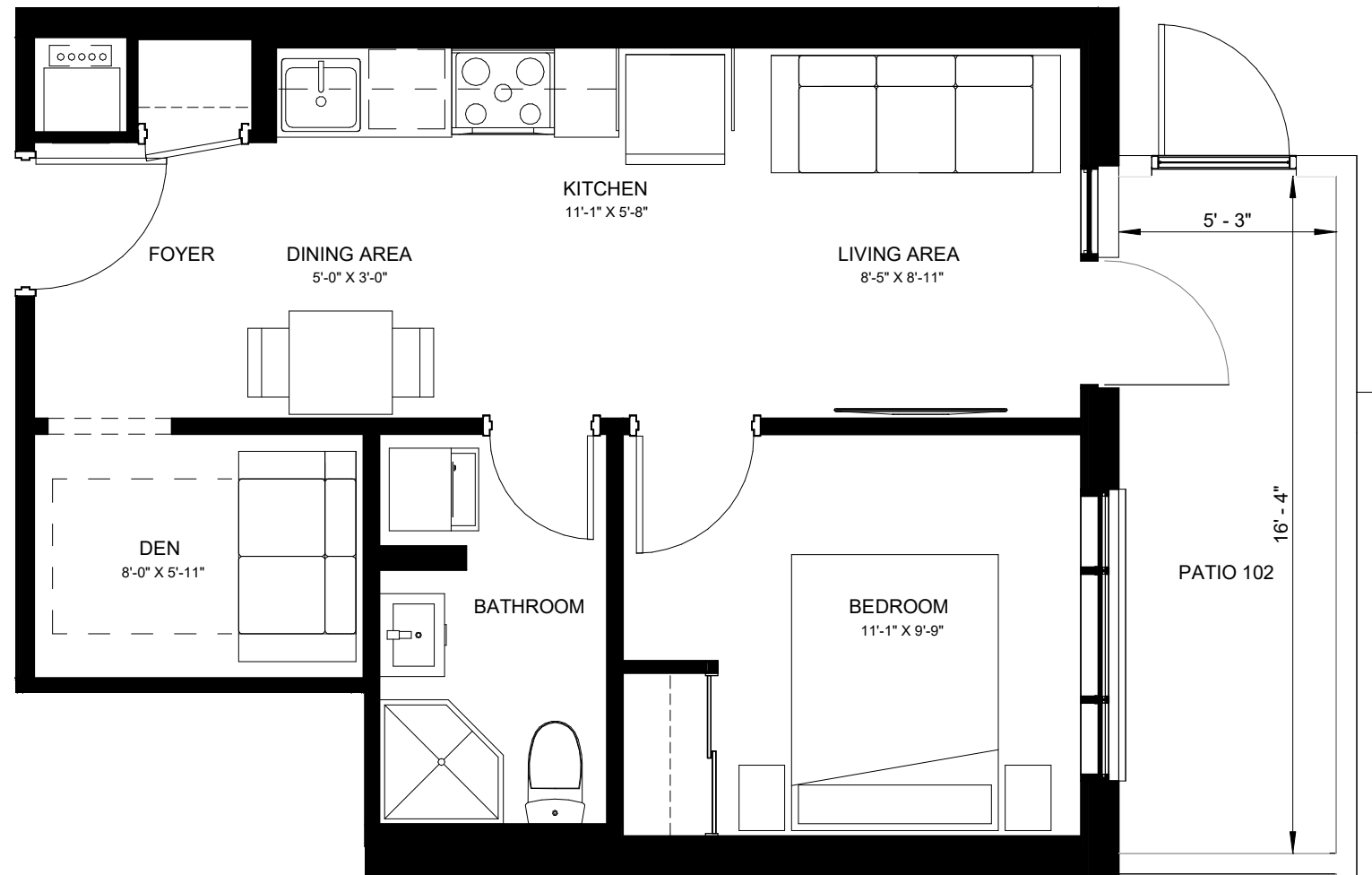

LEVEL 1

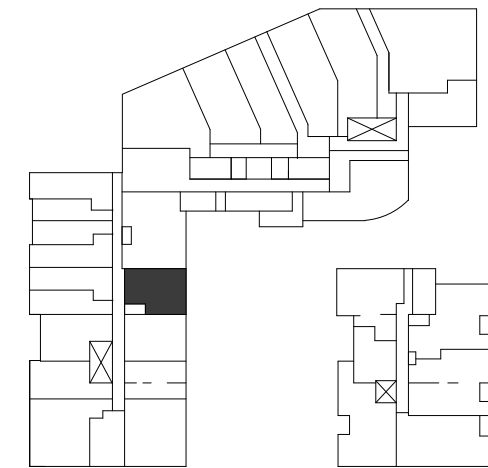

LEVEL 2

UNITS - 102- 508 SF
201- 508 SF

SUITE TYPE C508
1107 MAIN ST. W

19052

SRM[↗]
architects+
urban*designers

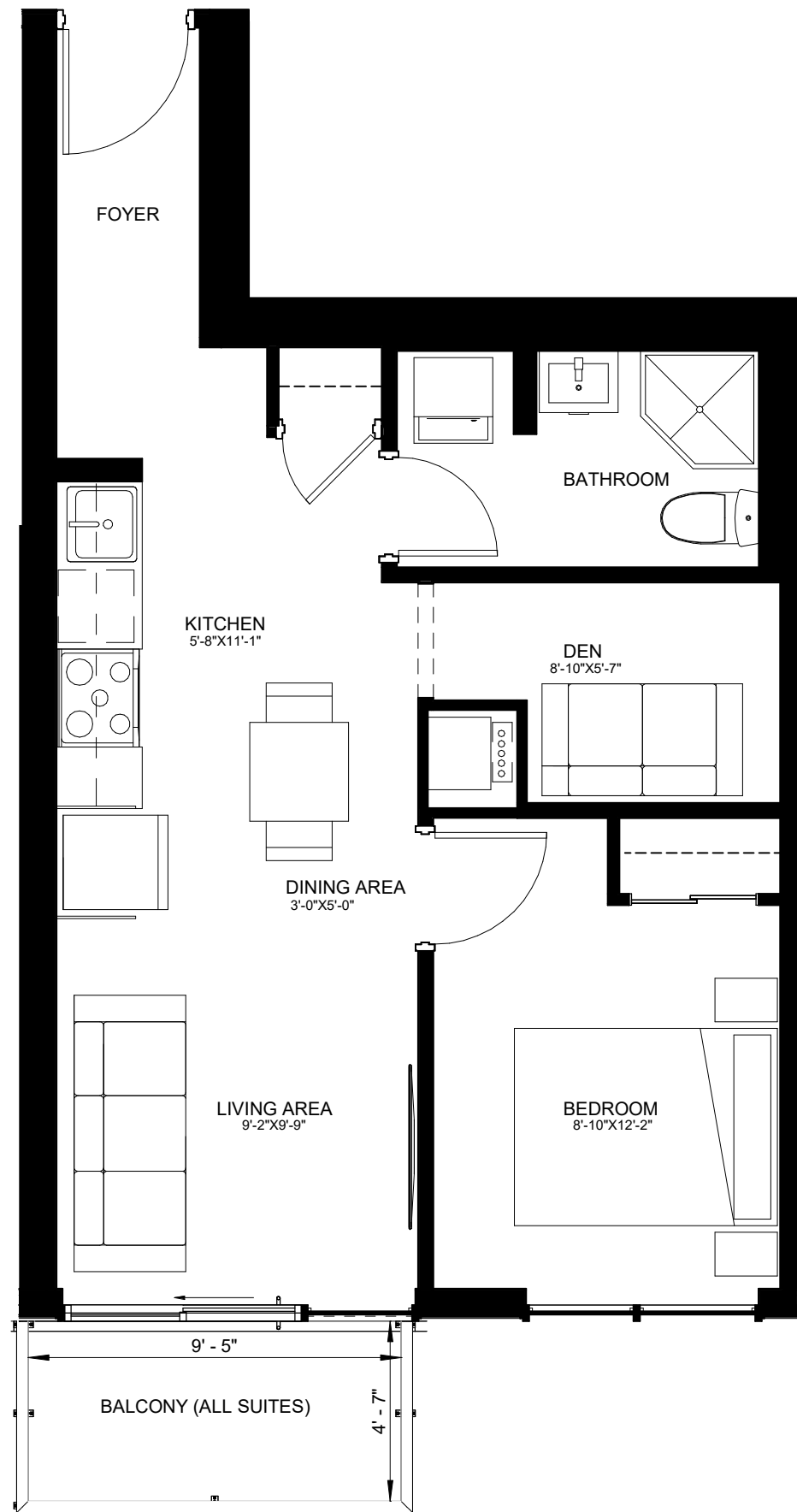
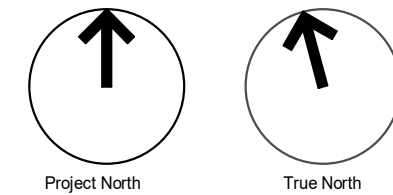

- UNITS- 301/343- 517 /521 SF
 401/446 - 517 /521 SF
 501/533 - 517 /521 SF
 601/627 - 517 /521 SF
 701/727 - 517 /521 SF
 801/812 - 517 /521 SF
 901/912 - 517 /521 SF
 1001/1012 - 517/521 SF
 1101/1112 - 517/521 SF
 1201/1212 - 517/521 SF
 1301/1311 - 517/521 SF
 1401/1411 - 517/521 SF
 1501/1511 - 517/521 SF

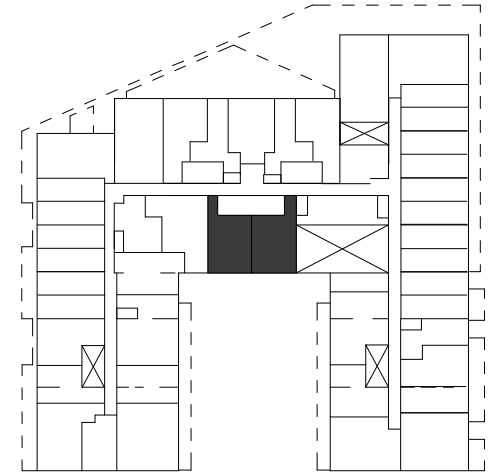

LEVEL 3

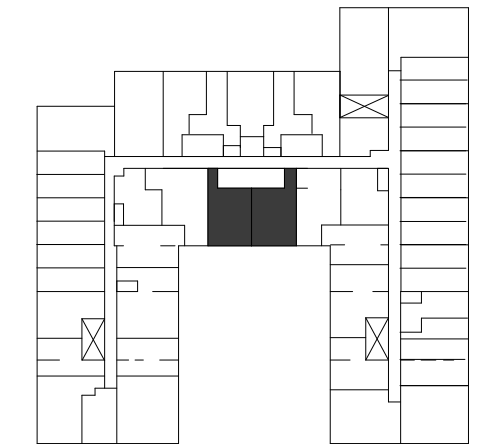

LEVEL 4

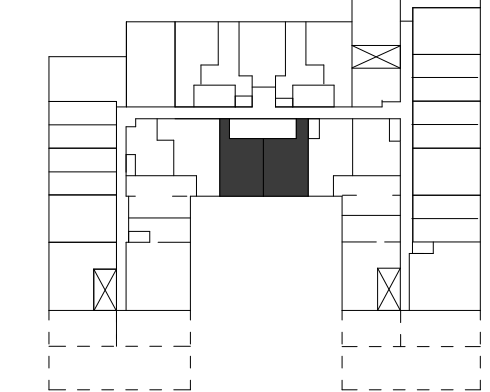

LEVEL 5

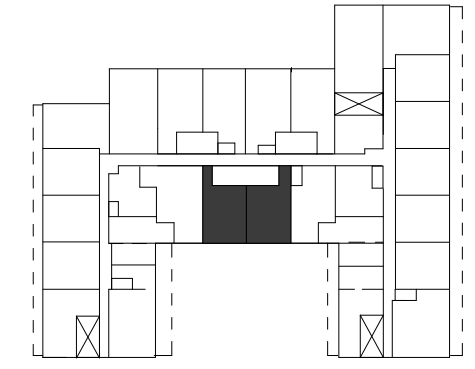

LEVEL 6-7

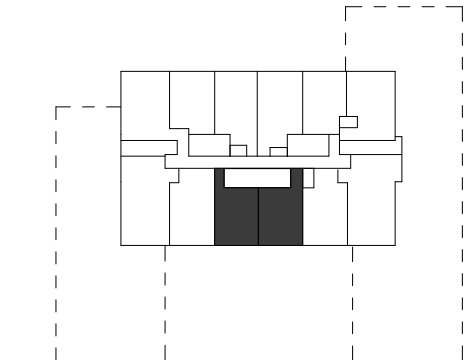

LEVEL 8

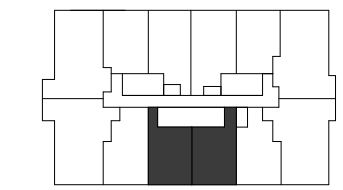

LEVEL 9-12

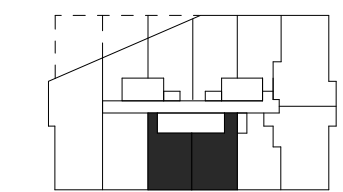

LEVEL 13-15

SUITE TYPE C517/521
 1107 MAIN ST. W

19052 **SRM**
 architects+
 urban*designers

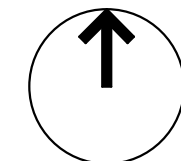

Project North

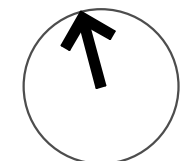

True North

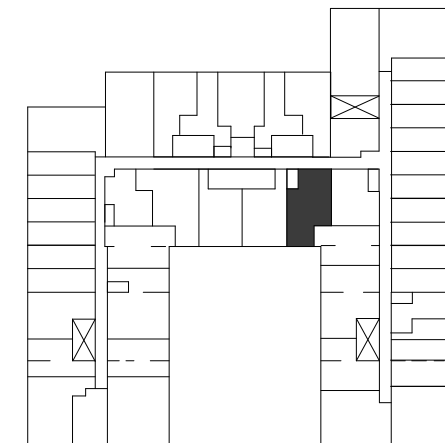
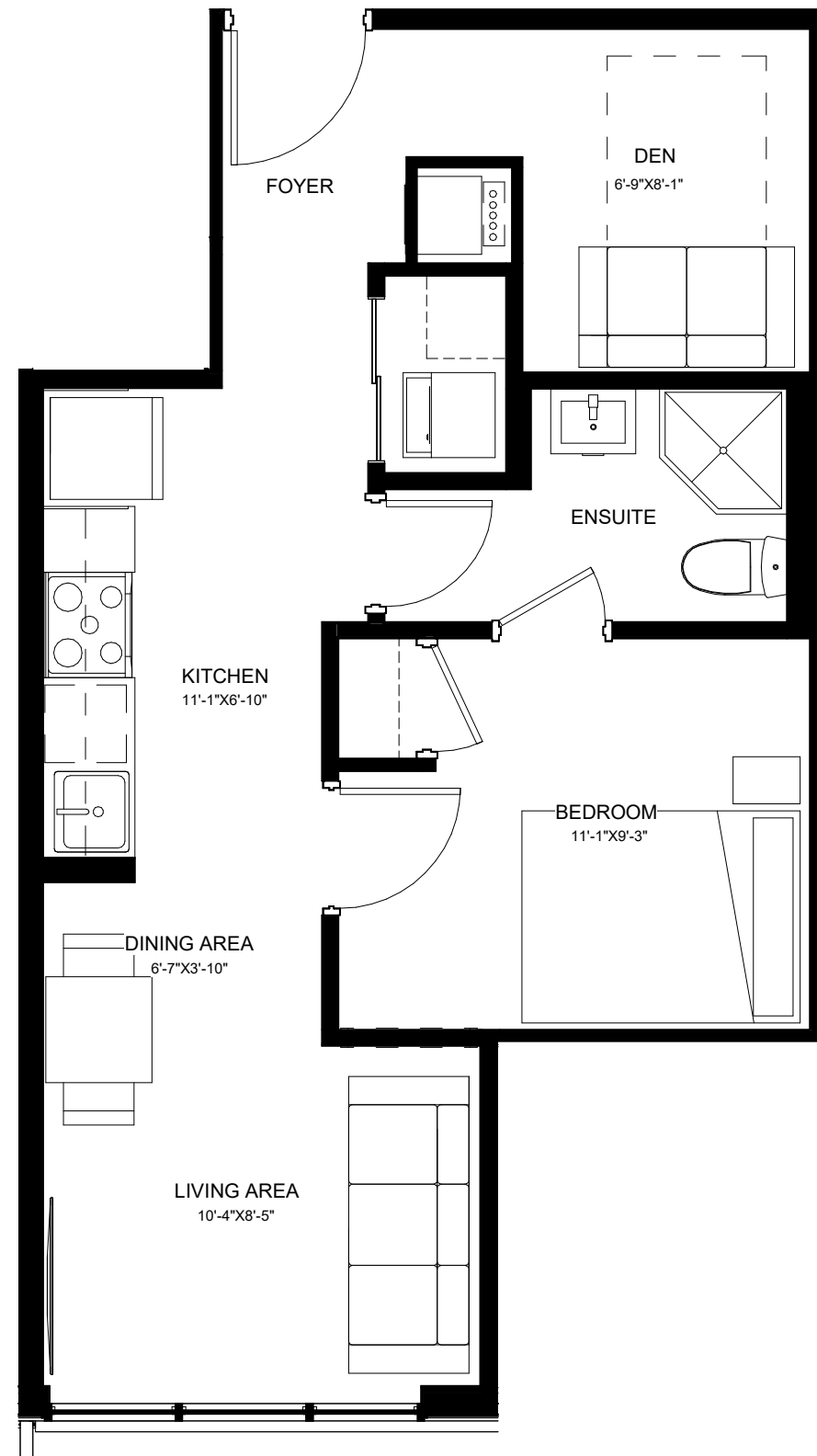

LEVEL 4

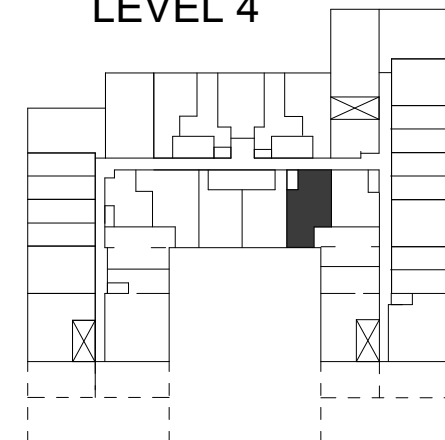

LEVEL 5

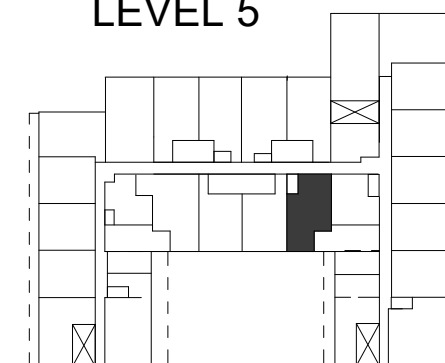

LEVEL 6-7

UNITS - 445 - 518 SF
 532 - 518 SF
 626 - 518 SF
 726 - 518 SF

SUITE TYPE C518

1107 MAIN ST. W

19052



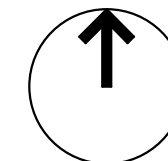

Project North

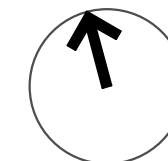

True North

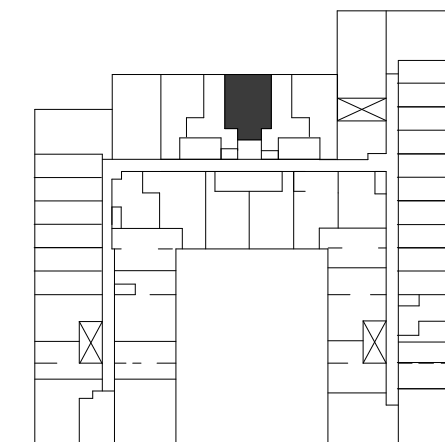
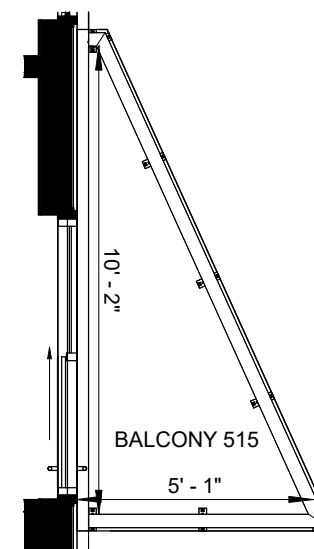
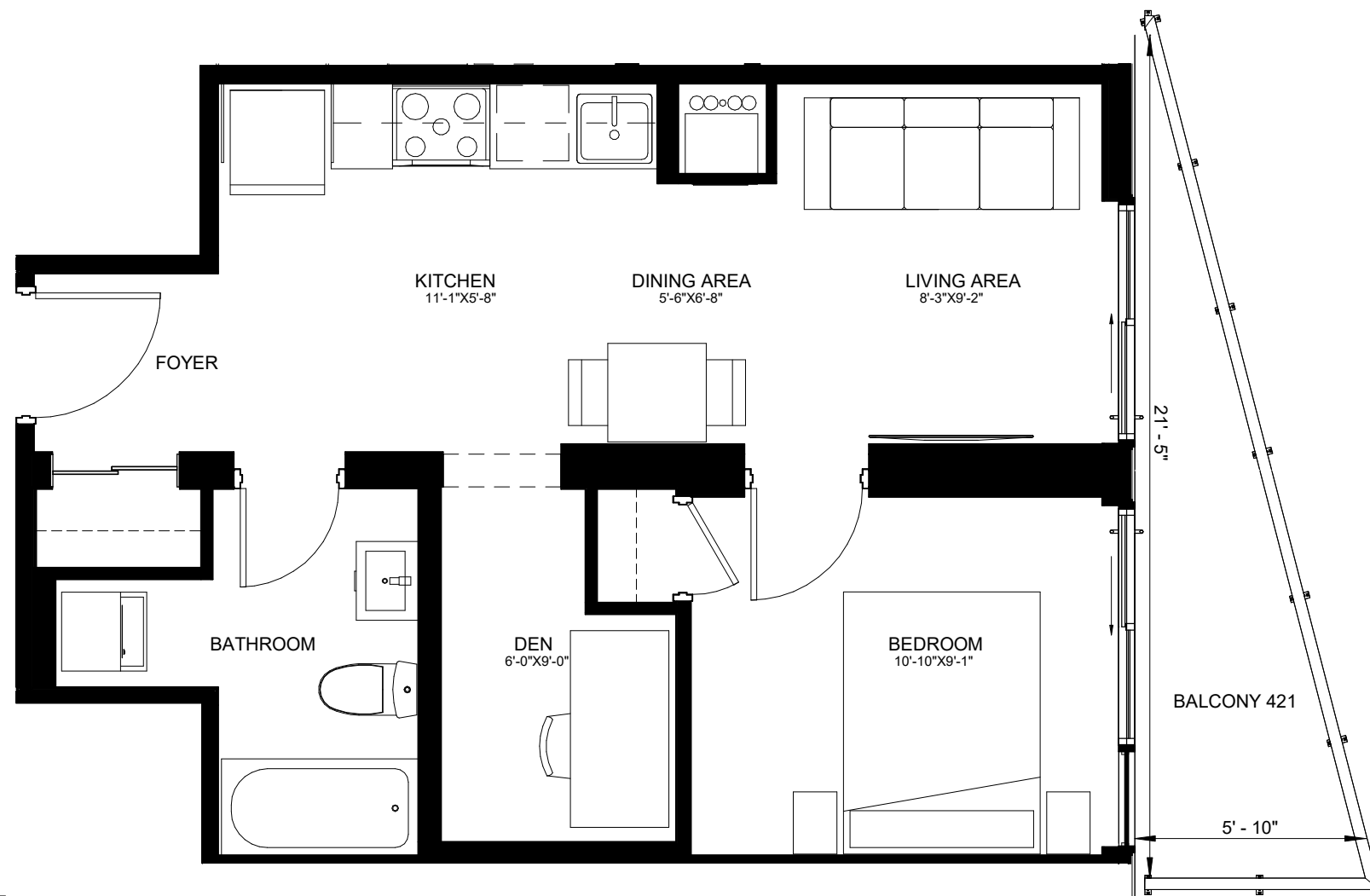

LEVEL 4

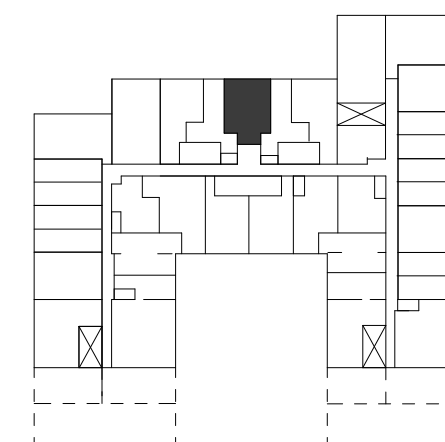

LEVEL 5

UNITS - 421 - 526 SF
515 - 526 SF

SUITE TYPE C526

1107 MAIN ST. W

19052

SRM[↗]
architects+
urban*designers

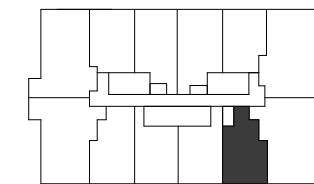
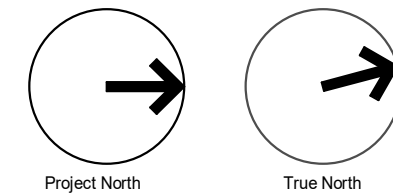

LEVEL 9-12

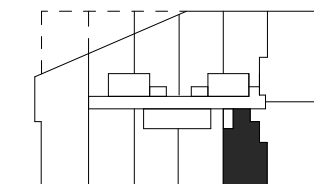

LEVEL 13-15

- UNITS - 911- 527 SF
- 1011- 527 SF
- 1111- 527 SF
- 1211- 527 SF
- 1310- 527 SF
- 1410- 527 SF
- 1510- 527 SF

SUITE TYPE C527

1107 MAIN ST. W

19052



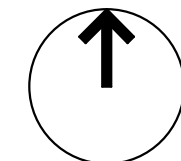

Project North

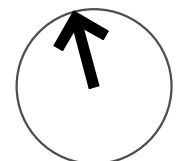

True North

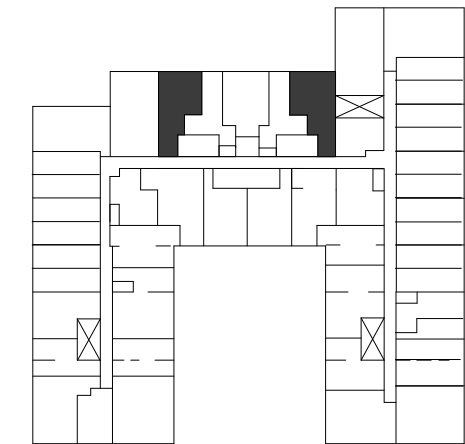
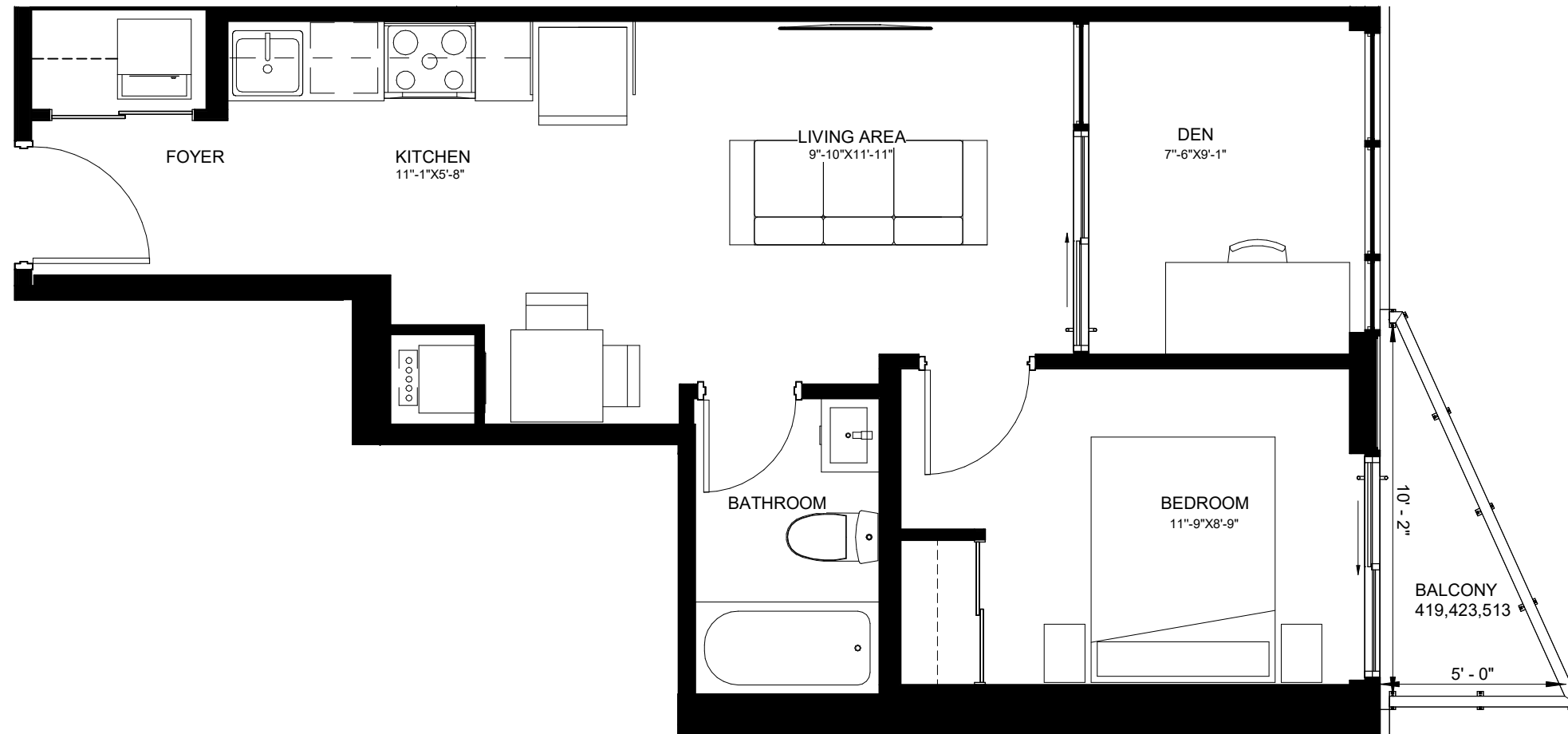

LEVEL 4

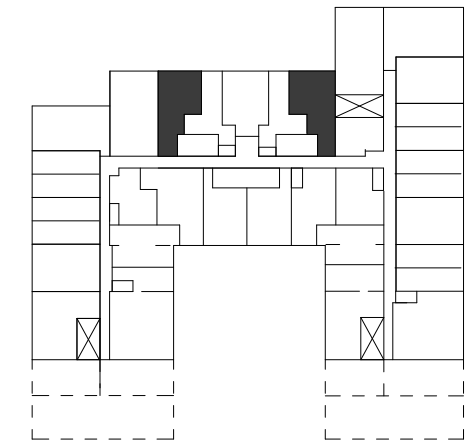

LEVEL 5

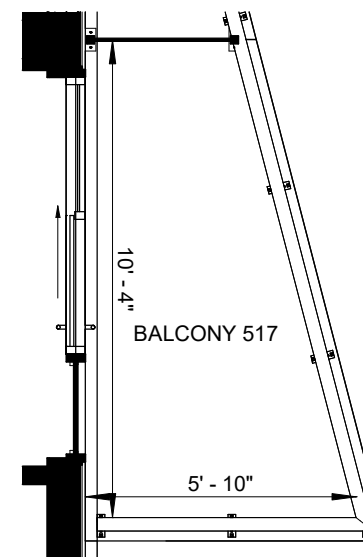

UNITS - 419 - 537 SF
 423 - 534 SF
 513 - 537 SF
 517 - 534 SF

SUITE TYPE C537

1107 MAIN ST. W

19052

SRM[↗]
 architects+
 urban+designers

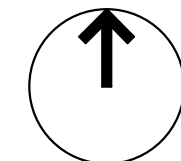

Project North

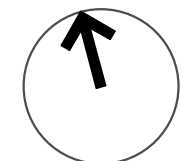

True North

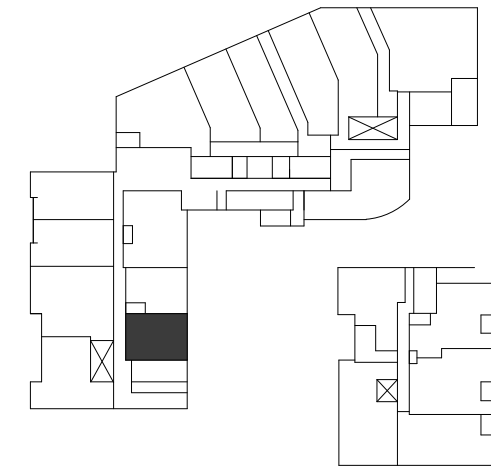
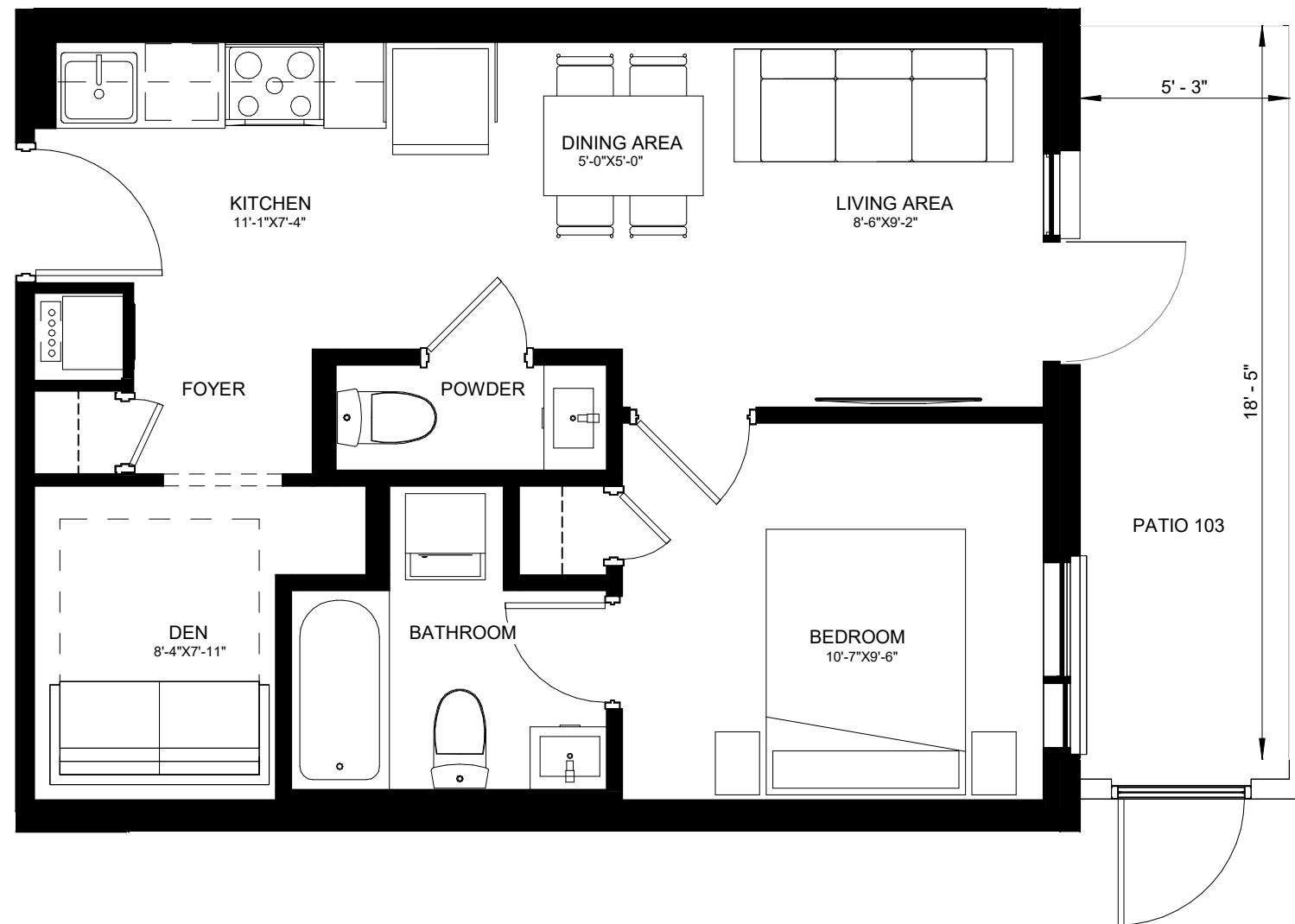

LEVEL 1

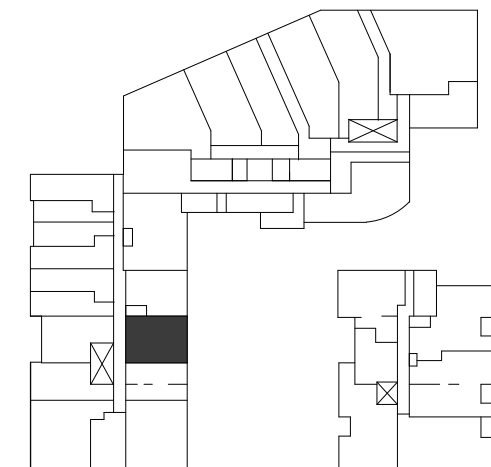

LEVEL 2

UNITS - 103 - 531 SF
202 - 532 SF

SUITE TYPE D531
1107 MAIN ST. W

19052

SRM
architects+
urban+designers

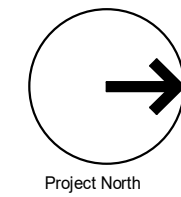

Project North

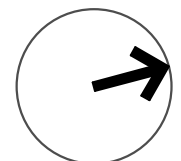

True North

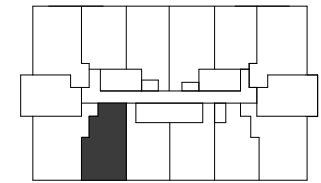

LEVEL 9-12

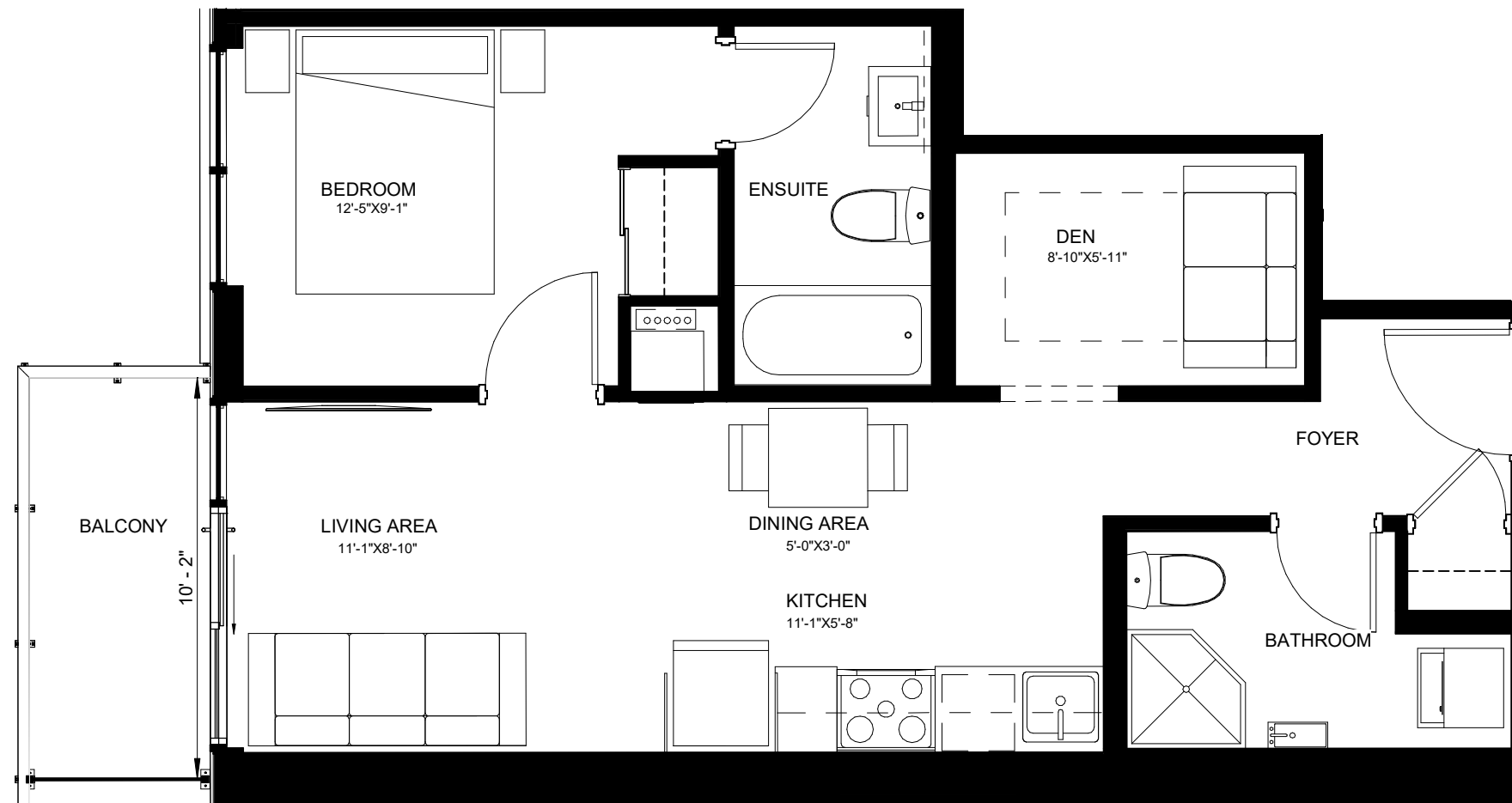

UNITS - 902 - 571 SF
 1002 - 571 SF
 1102 - 571 SF
 1202 - 571 SF

SUITE TYPE D571
 1107 MAIN ST. W

19052



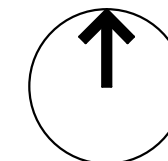

Project North

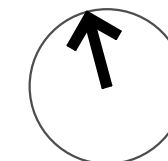

True North

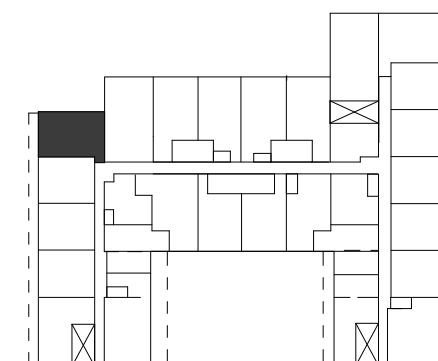

LEVEL 6

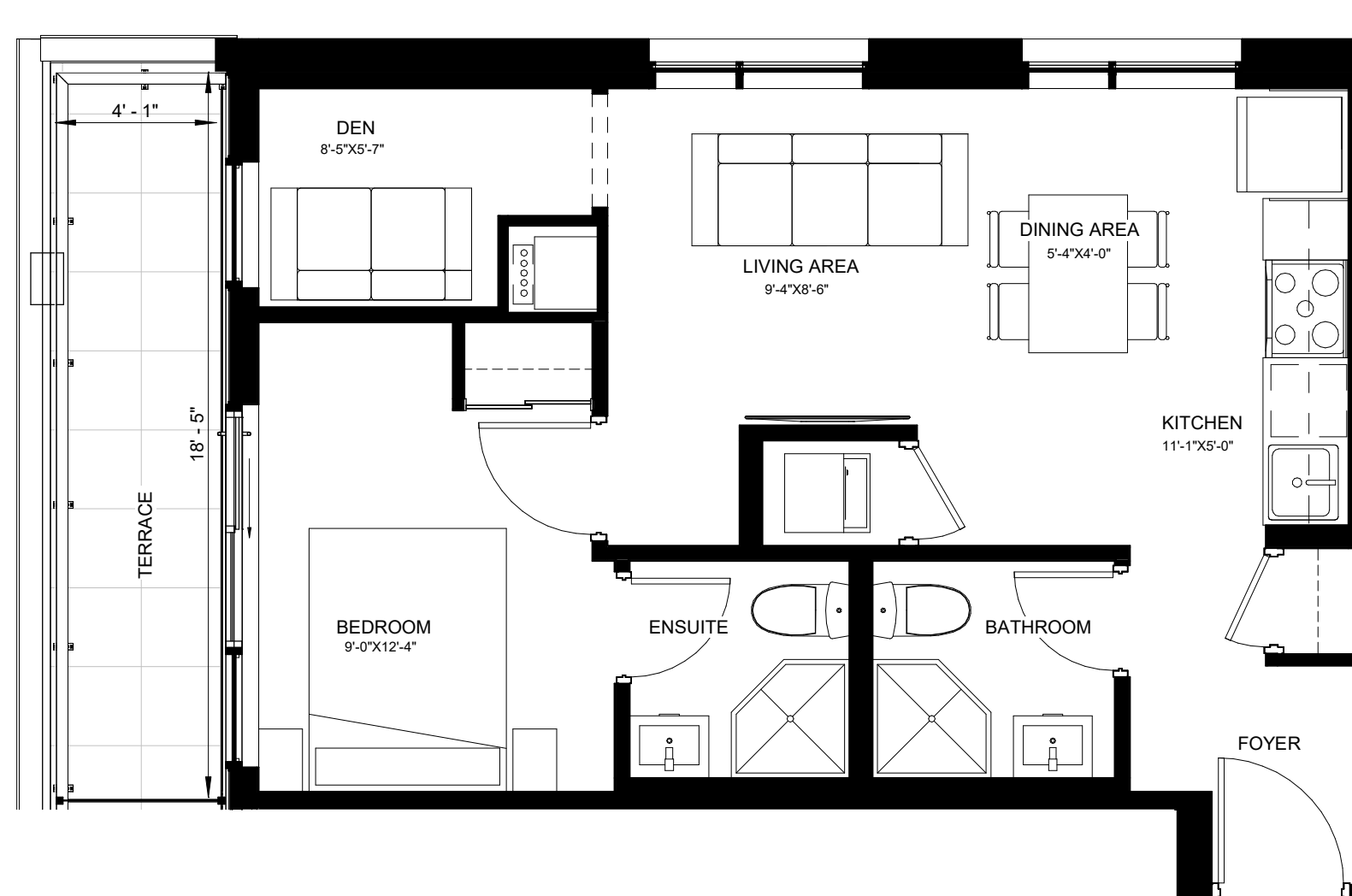

UNIT - 609 - 574 SF

SUITE TYPE D574

1107 MAIN ST. W

19052

SRM[↑]
architects+
urban+designers

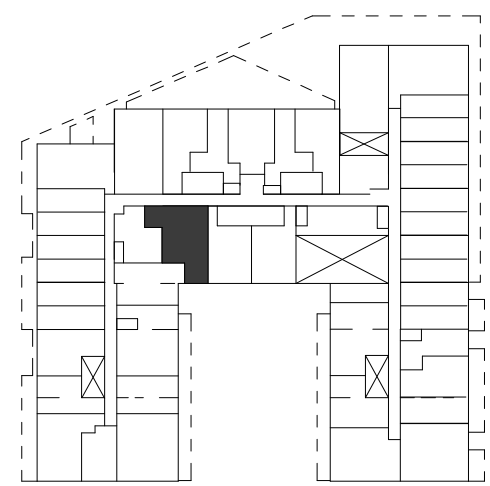
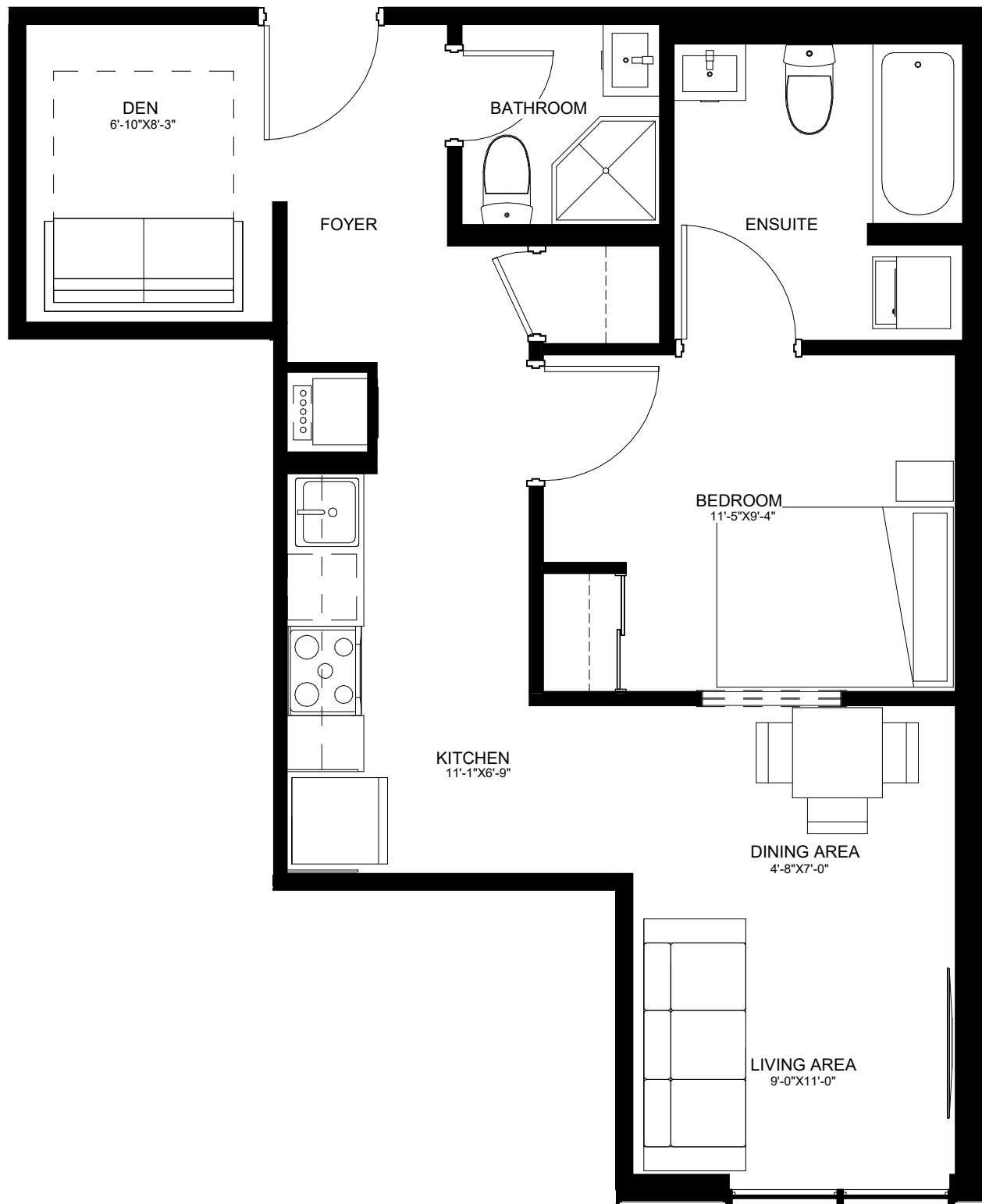

LEVEL 3

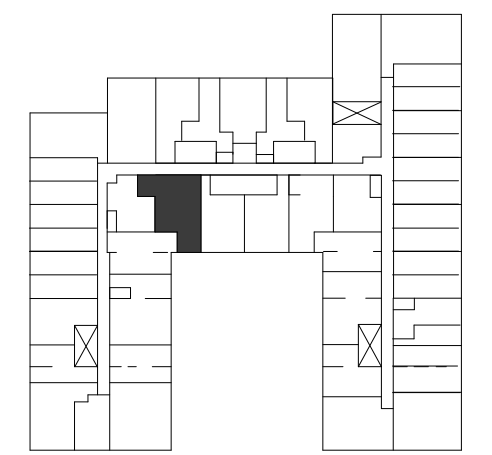

LEVEL 4

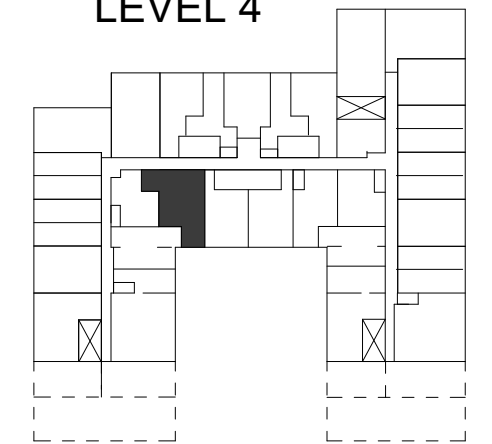

LEVEL 5

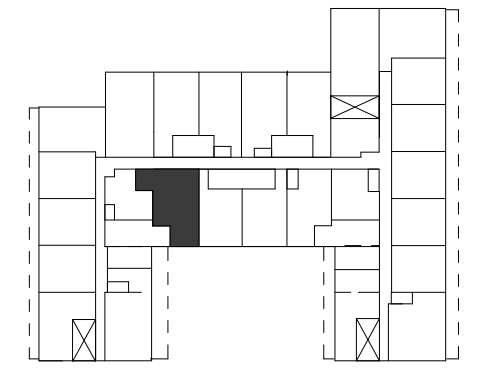

LEVEL 6-7

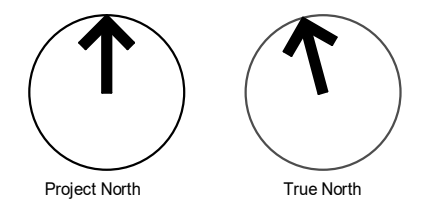

- UNITS - 302 - 627 SF
- 402 - 627 SF
- 502 - 627 SF
- 602 - 627 SF
- 702 - 627 SF

SUITE TYPE D627
 1107 MAIN ST. W

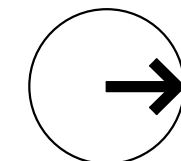

Project North

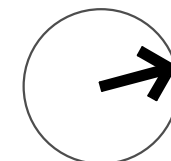

True North

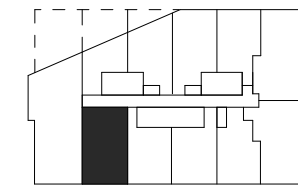

LEVEL 13-15

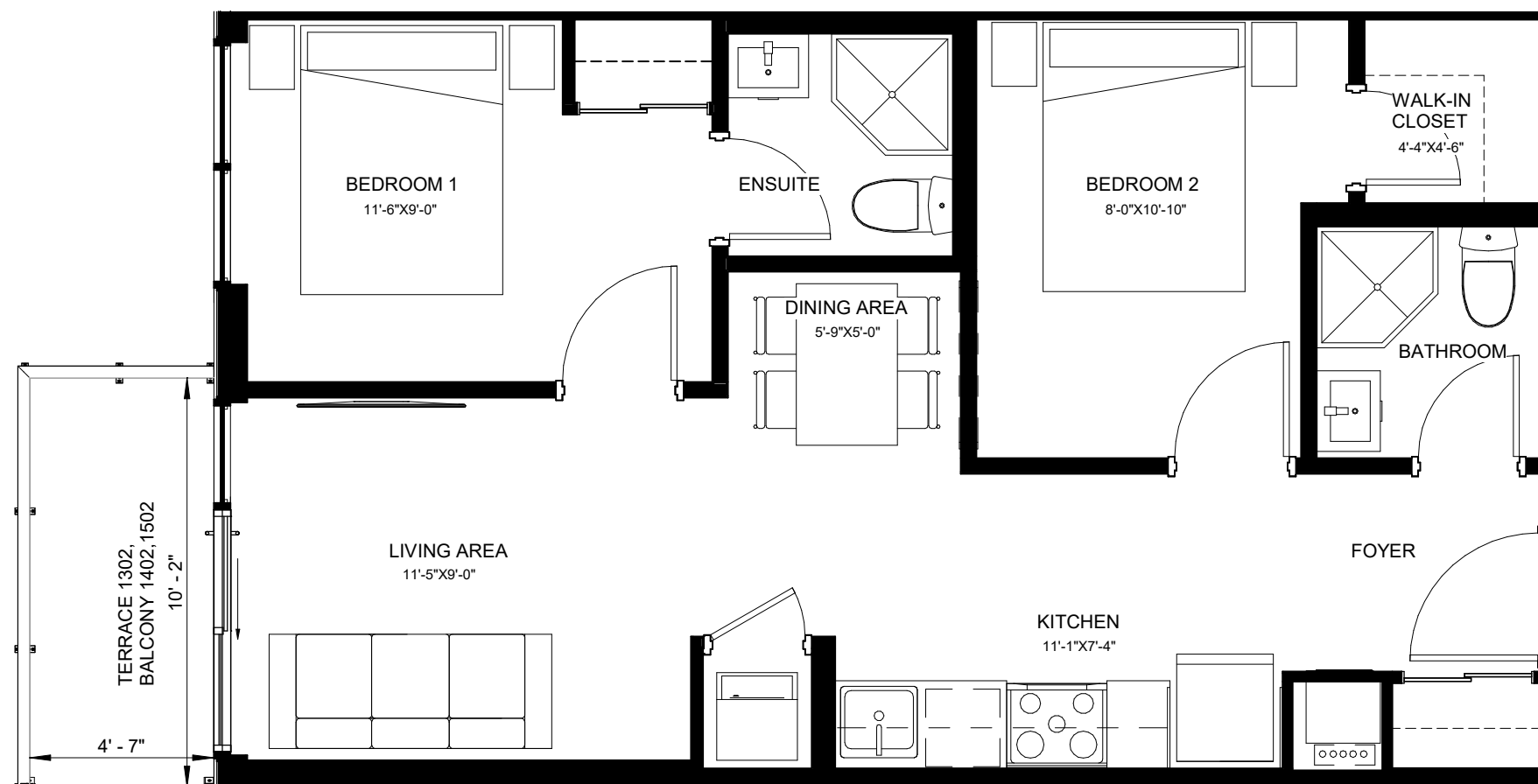

UNITS - 1302 - 640 SF
 1402 - 640 SF
 1502 - 640 SF

SUITE TYPE E640

1107 MAIN ST. W

19052

SRM[↑]
 architects+
 urban+designers

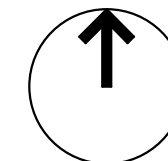

Project North

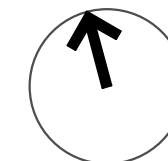

True North

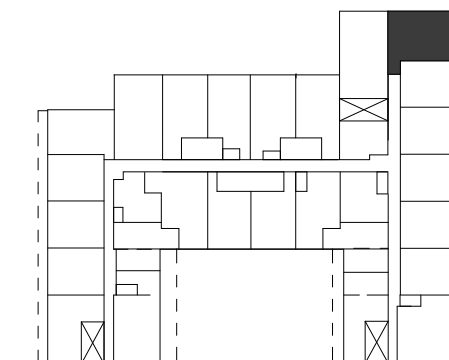

LEVEL 7



UNIT - 716 - 657 SF

SUITE TYPE E657

1107 MAIN ST. W

19052

SRM ↗
 architects+
 urban+designers

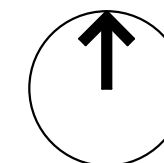
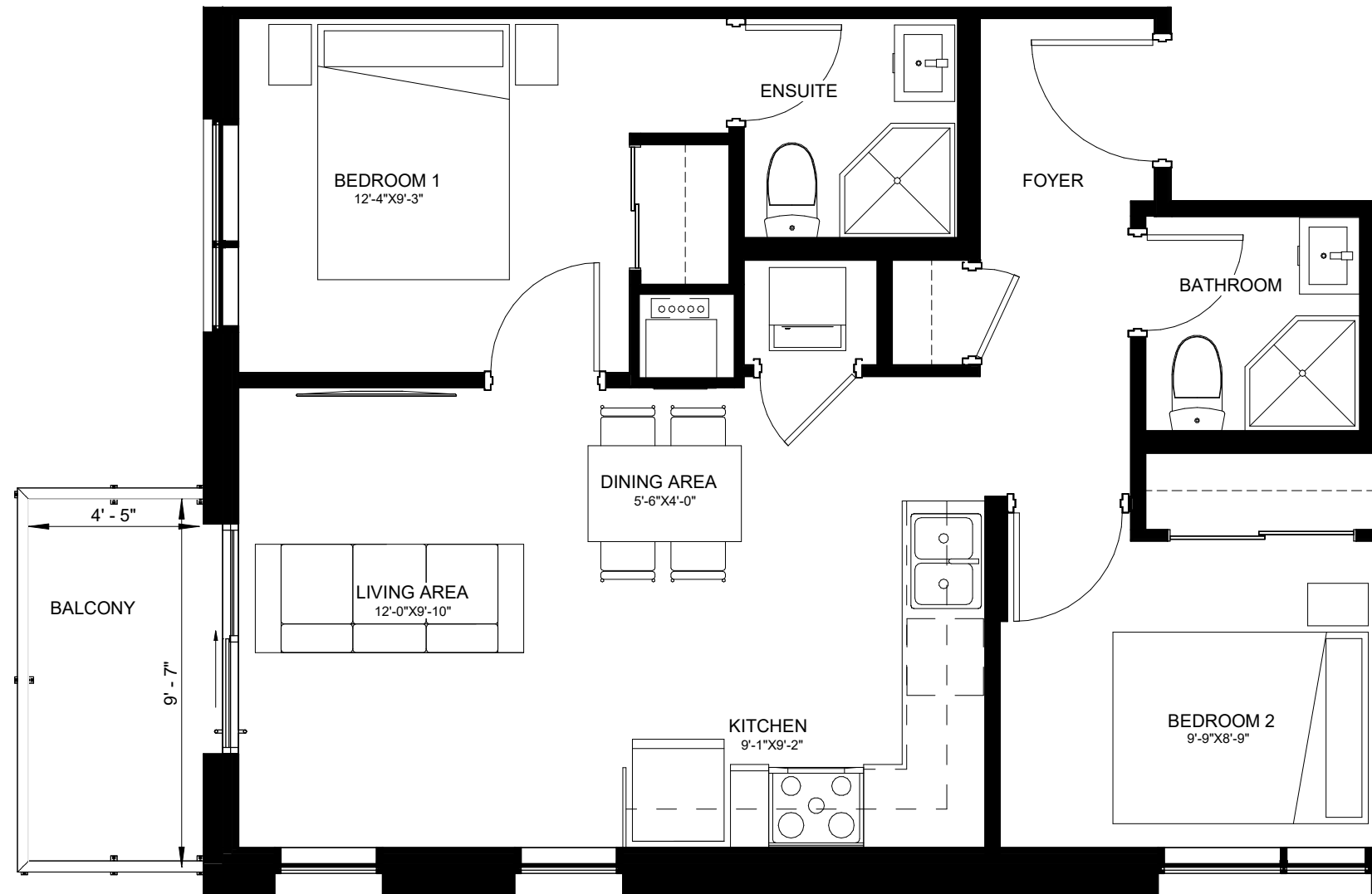

Project North

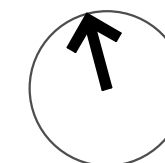

True North

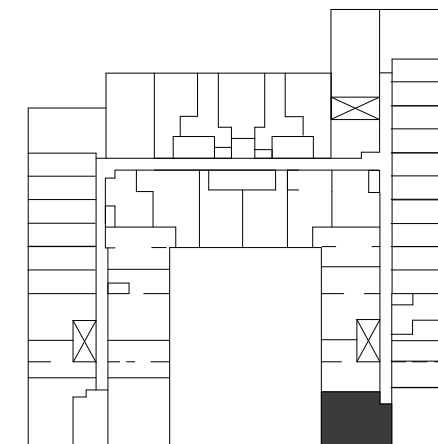

LEVEL 4

UNIT - 440 - 684 SF

SUITE TYPE E684

1107 MAIN ST. W

19052

SRM[↗]
architects+
urban*designers

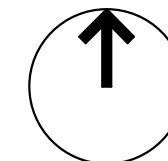

Project North

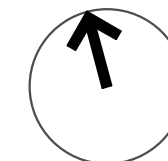

True North

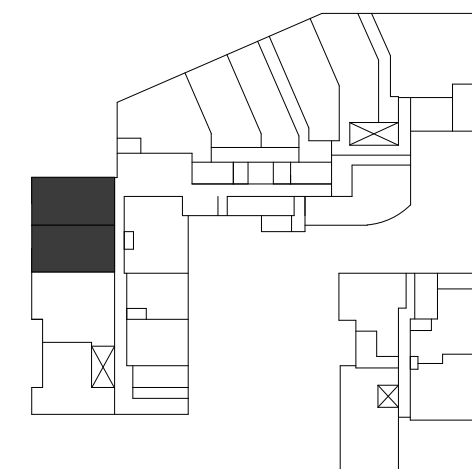
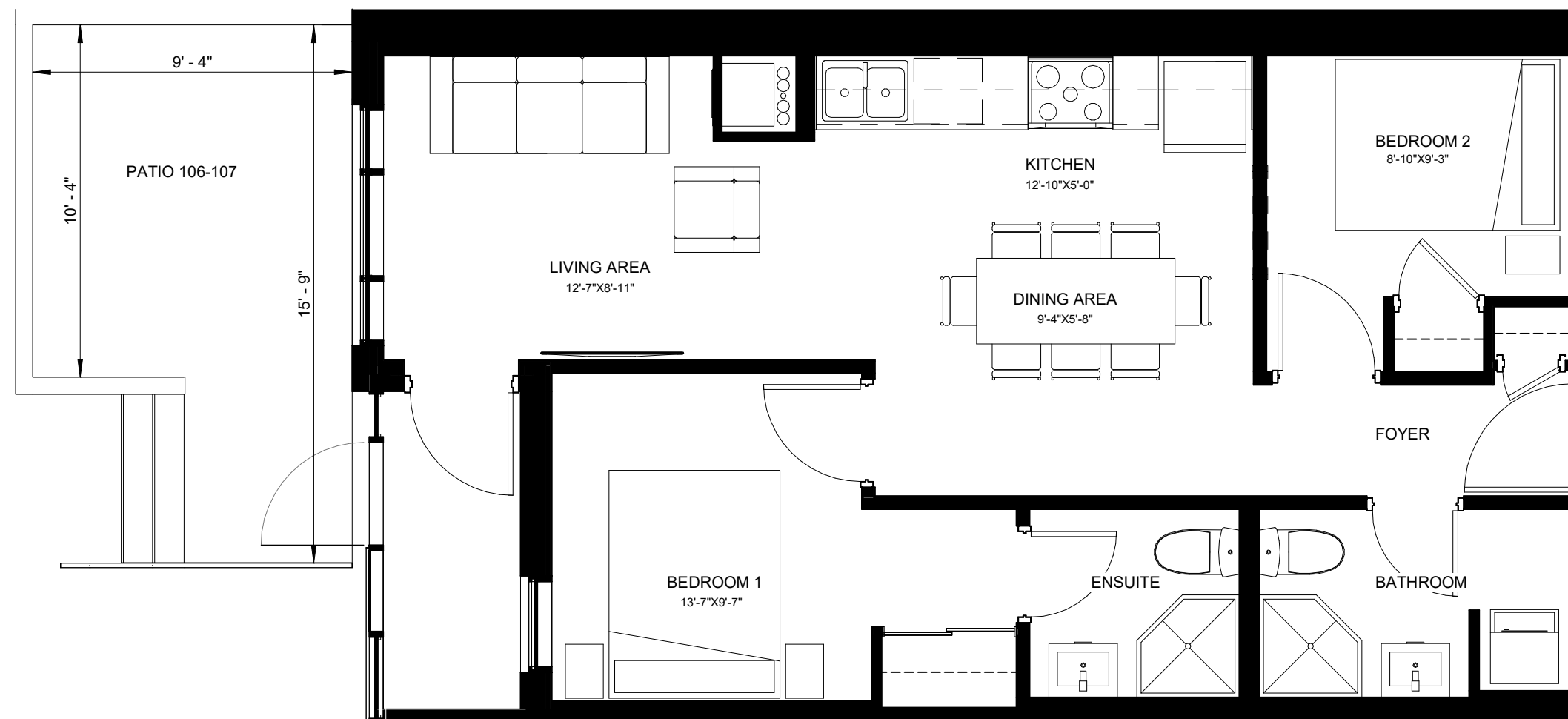

LEVEL 1

UNITS - 106 - 682 SF
107 - 703 SF

SUITE TYPE E703

1107 MAIN ST. W

19052

SRM
architects+
urban*designers

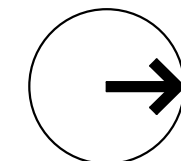

Project North

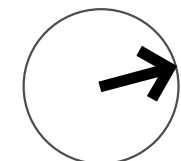

True North

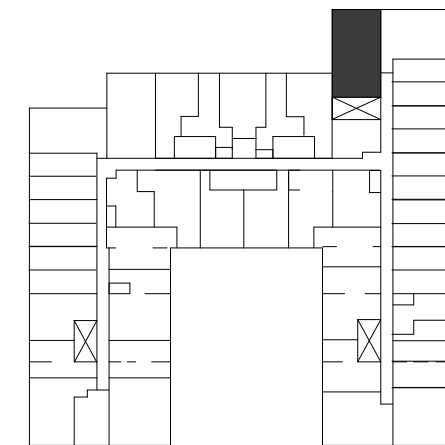
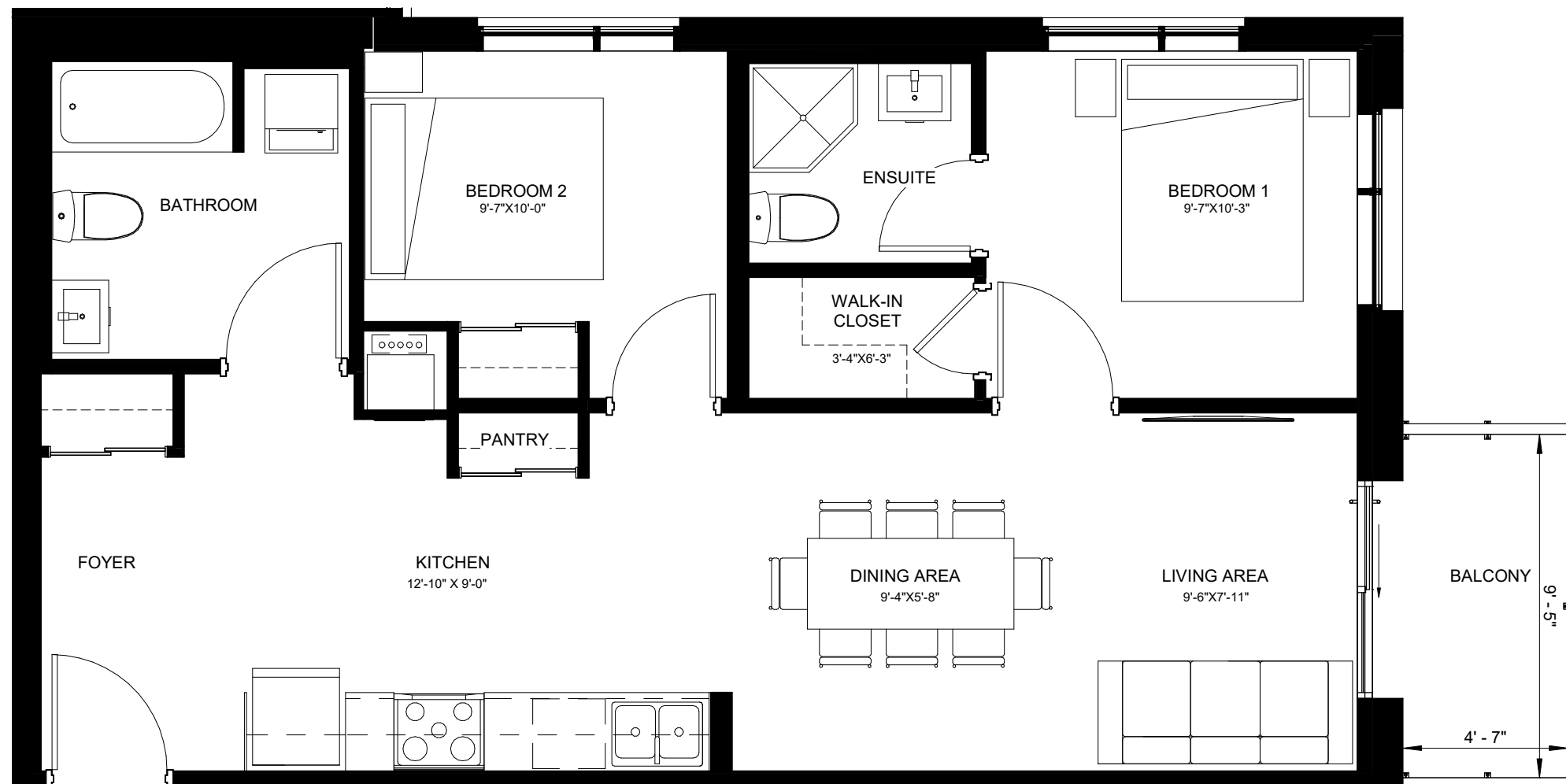

LEVEL 4

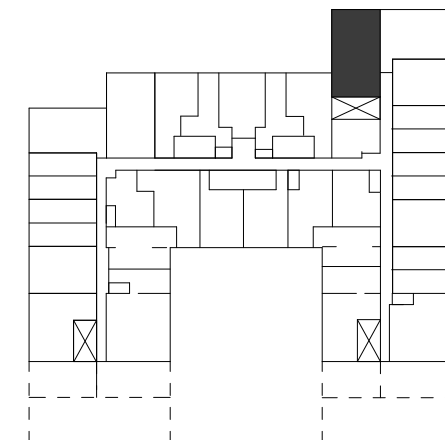

LEVEL 5

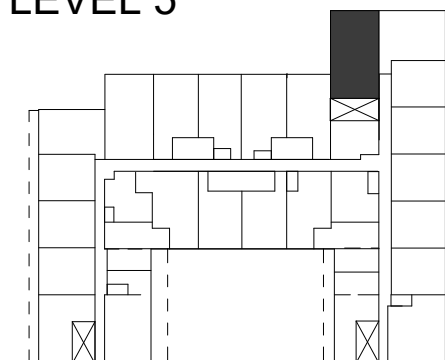

LEVEL 6-7

SUITE TYPE E790

1107 MAIN ST. W

19052

